

ENERGY STORAGE SYSTEM USER'S MANUAL



Catalog

❖ Installation notice.....	2
◆ Inverter Safety.....	3
◆ Battery Safety.....	4
◆ Installation Safety.....	4
◆ Product Key Features.....	4
❖ Introduction to working mode.....	5
❖ Outward appearance.....	7
◆ Front panel.....	7
◆ Side panel.....	9
❖ DC wiring.....	10
❖ AC wiring.....	11
❖ FAN Operation.....	14
❖ Connection diagram.....	14
❖ Solar panel and battery connection diagram.....	16
◆ Solar panels in series.....	16
◆ Solar panel in parallel.....	16
❖ LED indicator and LCD introduction.....	16
◆ LED indicator.....	17
◆ LCD info.....	18
◆ LCD information.....	19
◆ Hybrid solar input information.....	20
◆ Information Service.....	20
❖ parameter setting.....	22
❖ Fault code and repair.....	28
❖ buzzer alert.....	30
❖ Specifications.....	31

❖ Installation notice



Important Safety Instructions



Please save these instructions.

This manual contains important safety, installation, and operating instructions for the inverter, please read the product manual carefully before using this product.

- Check the package is complete before opening. After opening packing please check the accessories, The accessories includes 1PCS user manual and check the inverter is still protected well after transportation.
- If you find damage or missing parts, please do not turn on the machine and contact your dealer.
- Please keep the packing box and materials for next delivery if needed.
- This series of products is very heavy, please handle it carefully.
- The inverter installation must be more than 30cm away from the wall, well ventilated, free of water, flammable gases and corrosives. As shown in the figure:

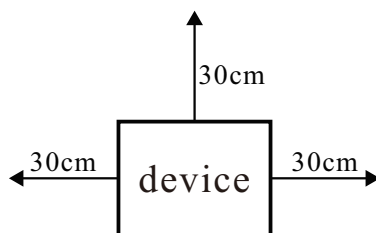

- Not good to place in a corner, on the side, or upside down. Put away from heat sources. Avoid direct sunlight, ensure that the front panel, rear panel, and fan inlets have good ventilation.
- The environment temperature should be between 0 ° C and 40 ° C/32°F -104°F.
- If the machine is disassembled and used in a low temperature environment, Water may condense on it. Only operate after drying both internal and external part of the machine, otherwise you will be at risk of shock
- Please install the inverter near the mains input socket or switch where it will be easy to unplug the mains input or cut off the power supply during an emergency situation.

- The external battery should not be exposed. It should be installed in the battery cabinet.
- The DC input cable between the inverter and the battery should be short as possible.
- Do not stack goods on the inverter.
- Before the load is connected to the inverter, the load must be turned off before wiring. The inverter must be connected to a socket with over current protection, and the machine must be safely grounded.
- The power outlet should be safely grounded.
- To ensure no output from the inverter, all switches must be turned off first, then turn off the mains power. Whether the inverter has an input or not, turning off the inverter does not guarantee that the internal parts have no power.
- Powering an inductive load: When powering an inductive load such as motor, display and laser printer, the inverter capacity should be three times the starting power of the load/equipment.
- It is often needed to keep charging to extend the battery life. When the inverter is connected to the normal mains, whether inverter is on or off, it still keep charging the battery, and provides overcharge protection.
- Normally, the battery life is three to five years. If there is a problem with the battery, it must be replaced early. When replacing the battery, it must be operated by professionals.
- It is not recommended to replace the battery individually. When replacing the battery, you should follow the battery supplier's operating instructions.

Note:

- Before replacing the battery, you must cut off all power connected to the machine: mains switch, battery switch, etc.
- Take off metal objects such as rings and watches.
- Use tool as handles and screwdrivers. Do not put tools or other metal objects on the battery.
- It is normal for a small spark when connecting the battery cable, but will not harm human safety and inverter.
- **Note: Do not short the battery positive and negative terminals, you can't reverse the battery connection.**

◆ **Inverter Safety**

The inverters are suitable for Battery Banks ONLY.

Always make sure the inverter is in OFF position and disconnect all AC and DC connections when working on any circuit associated with the inverter. Never connect the AC output of the unit directly to an Electrical Breaker Panel/ Load Centre which is also fed from the utility power / generator. When connecting battery terminals, ensure the polarity of the battery connections is correct. Incorrect polarity may cause permanent damage to the unit. Be careful when touching bare terminals of capacitors as they may retain high lethal voltages even after power is removed.

◆ **Battery Safety**

Do NOT let the positive (+) and negative (-) terminals of the battery touch each other.

Use sealed Lead-Acid, Flooded, Gel, AGM, Lithium batteries which must be deep cycle.

Explosive battery gases may be present while charging. Be certain there is enough ventilation to release the gases.

Be careful when working with large lead acid batteries. Wear eye protection and have fresh water available in case there is contact with the battery acid.

Over-charging and excessive gas precipitation may damage the battery plates and activate material shedding on them. Too high of an equalizing charge or too long of one may cause damage. Please carefully review the specific requirements of the battery used in the system.

◆ **Installation Safety**

The unit should be installed in a well-ventilated, cool, and dry environment.

Make sure the fans of the unit and the ventilation holes are not blocked.

Do not expose the unit to rain, moisture, snow, or liquids of any type.

◆ **Product Key Features**

- Suitable for mains power unstable or often off, and important equipment that requires backup power.
- This product adopts high-precision DSP control chip, precise detection circuit, advanced control technology .
- Intelligent temperature-regulating fan, efficient heat dissipation, extending system life.
- Pure sine wave output, Multiple working mode options
- Multiple electronic protections: short circuit protection, over voltage and under voltage protection, overload protection, Overheat / short circuit automatic restart(automatic restart three times).

- wide frequency and wide voltage input, can be used for diesel / gasoline generator input.
- 3-Stage battery charger with configurable charging current.
- 8 Pre-Set battery voltages including Lithium; User-defined option.

❖ Introduction to working mode

Work mode	Description
01 City power priority	When the mains power is available, the mains power supply power to the load, and when the mains power is off, the battery will supply power to the load and charging to battery.
02 Energy saving mode	When the inverter is in battery priority mode and the output load is less than 1%-10% of the power(set by the P7 ,10% default), the AC output will be turn off, The inverter restarts every 1 minute, and checks whether the load is greater than the set power. When the connected load is greater than the minimum setting, the inverter restarts output. This function is to reduce the battery loss and extend the battery backup time.
03 Battery priority mode	The battery supply power to the load. When the battery voltage is lower than the set battery voltage (voltage set by PA item), use City power supply power to the load. When the battery voltage is restored , the battery will supply power to the load again (When battery power is low or solar power is off, the inverter can be set by PC to use main power charging the battery or not).
04 Mains priority unattended mode	Inverter automatically turn on when connected to mains power or battery voltage is normal (not include inverter first time use) . But when the battery discharge voltage lower than battery voltage by set F4 (F4: set the battery low voltage power is turn off), the

	<p>power will be turned off. Inverter on only mains power is coming or turn on by hand.(mains is charging is or not set by PC).</p>
<p>05 Battery priority unattended mode</p>	<p>When the battery voltage is normal ,the inverter automatically turn on and supply power to the load. When the battery voltage is low, mains supply power to the load. When the battery discharge to battery low voltage shutdown (PL setting), the inverter enters standby and waits for the mains power or solar charging to battery .When the battery voltage is restored (PN setting),the inverter automatically turn on .But when the battery discharge voltage is lower than battery voltage (set by F4), power will be turn off . Inverter can only be turned ON only by mains power input or turned ON by hand.</p>
<p>06 Solar priority mode</p>	<p>1.Solar energy priority working mode (06 mode) If the battery voltage is higher than 10.5V (PA program setting), solar and battery will provide power to the load at the same time. 2.When the battery voltage drops to 10.5V (PA program setting), the inverter will turn to bypass mode, utility provides power to the load . utility charging to battery or not can set by PC (ON/OFF/AUTO default). 3.When the inverter is in bypass mode, the battery recovers voltage higher than 13.2V (Pb setting), the solar input voltage is 5V higher than the battery voltage, and solar is available for 1 minute, the inverter uses solar and the battery provides power to the load.</p>

❖ Outward appearance

◆ Front panel

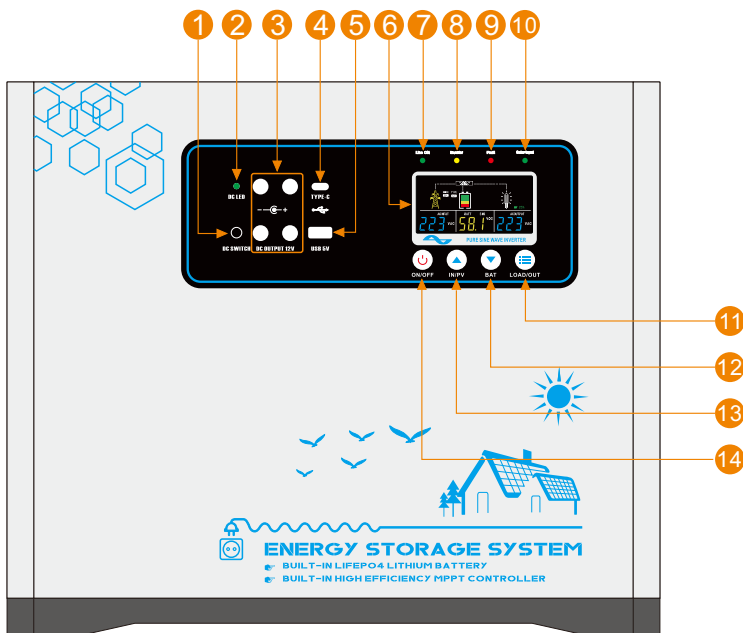

- | | |
|------------------------|-------------------------------|
| 1 DC Output Switch | 8 Inverter/charging indicator |
| 2 DC output indicator | 9 Fault indicator |
| 3 DC 12V Output Socket | 10 Solar Input indicator |
| 4 TYPE-C Output Socket | 11 AC output/LOAD (MENU) |
| 5 USB 5V Output Socket | 12 Battery (Down) |
| 6 LCD | 13 AC input/PV (Up) |
| 7 AC Input indicator | 14 ON/OFF |

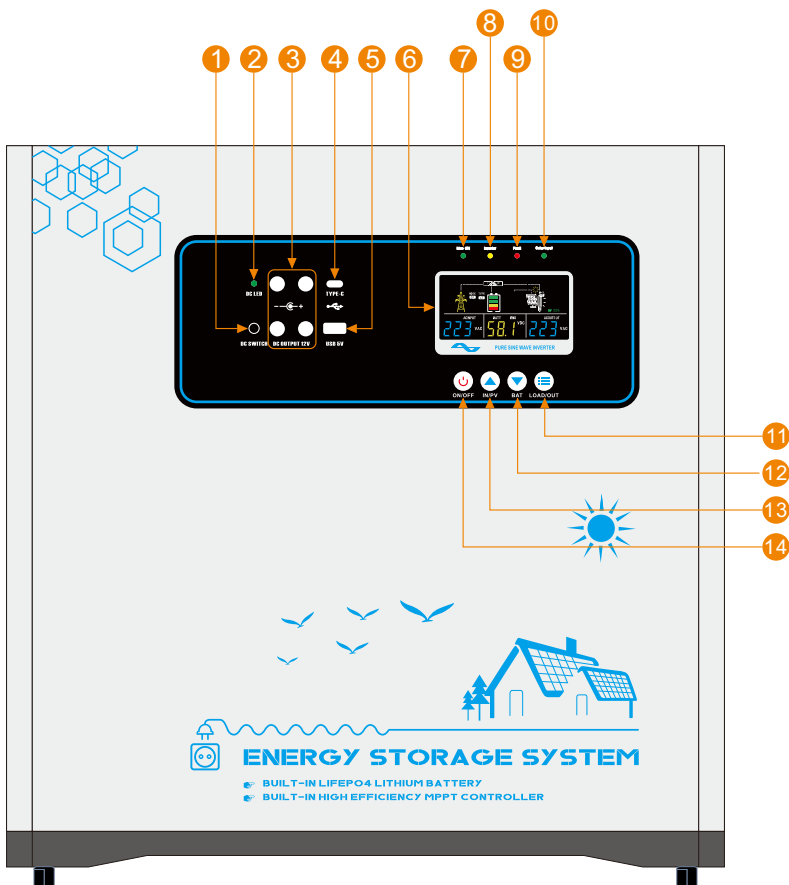

- | | |
|------------------------|-------------------------------|
| ① DC Output Switch | ⑧ Inverter/charging indicator |
| ② DC output indicator | ⑨ Fault indicator |
| ③ DC 12V Output Socket | ⑩ Solar Input indicator |
| ④ TYPE-C Output Socket | ⑪ AC output/LOAD (MENU) |
| ⑤ USB 5V Output Socket | ⑫ Battery (Down) |
| ⑥ LCD | ⑬ AC input/PV (Up) |
| ⑦ AC Input indicator | ⑭ ON/OFF |

◆ Side panel

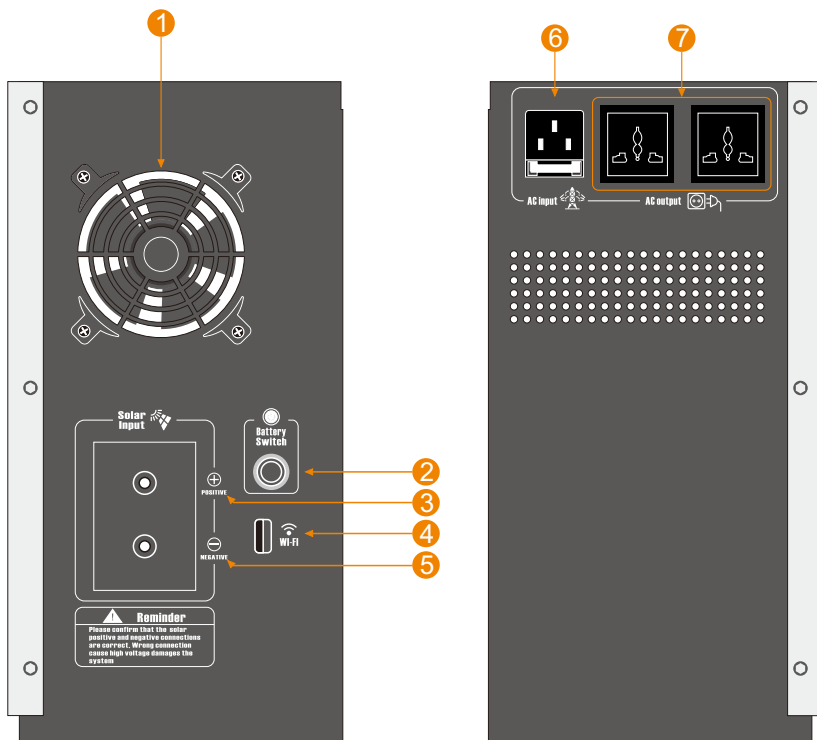

- ① Fan
- ② Battery Switch
- ③ Solar Input Positive socket
- ④ WiFi / Bluetooth (Optional)
- ⑤ Solar Input Negative socket
- ⑥ AC Input socket
- ⑦ AC Output socket

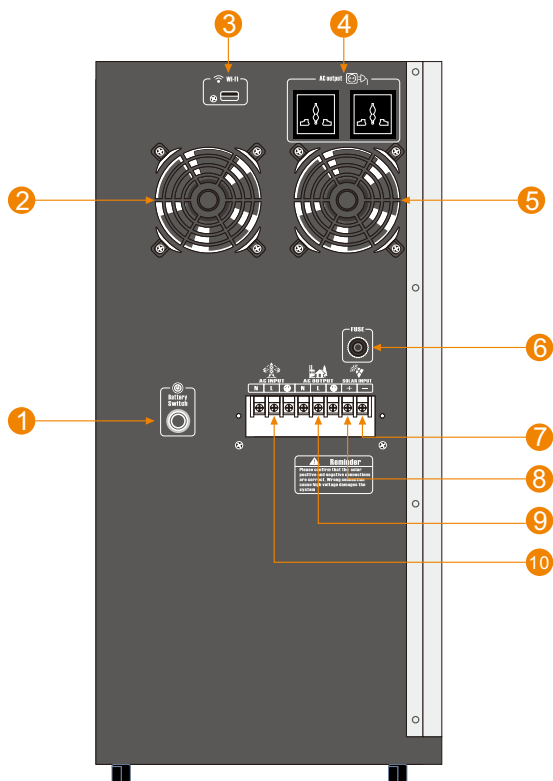

- | | | |
|-------------------------------|---------------------------------|---------------------------------|
| ① Battery Switch | ④ AC Output socket | ⑧ Solar Input Positive terminal |
| ② ⑤ Fan | ⑥ AC Input FUSE | ⑨ AC Output terminal |
| ③ WiFi / Bluetooth (Optional) | ⑦ Solar Input Negative terminal | ⑩ AC Input terminal |

❖ DC wiring



DC wiring not following the minimum DC requirement will cause irreversible damage to the unit.



Be careful of the positive and negative poles. Reversing the poles might cause permanent damage to the inverter. It will surely blow the internal fuse.

NOTE

Damage to the inverters due to reverse polarity is NOT covered by warranty.

NOTE

The input terminals of the inverters have large capacitors connected to them. Once a positive and negative wire are connected to the terminals, it will complete the circuit, and commence drawing a heavy current momentarily. As a result, there may be a sparking occurring even if the inverter is in the off position. To minimize sparking, it is recommended that the user have the appropriate size wire feeding into the inverters and/or install an external fuse leading into the inverter.

WARNING

Ensure all sources of DC power (i.e., batteries, solar, etc.) and AC power (utility power or AC generator) are de-energized (i.e., breakers opened, fuses removed) before proceeding—to prevent accidental shock

1. Unscrew the screw terminals along the edge of the side plate.
2. Gently remove DC Side plate to expose DC Terminals.
3. Connect the positive and negative DC Cables to their respective terminals and run them through the side panel.

WARNING

The Terminals must be clean to reduce the resistance in the cable connection. A buildup of dirt or oxidation may eventually lead to the cable terminal overheating during periods of high current draw.

- When installing DC cables, the following are recommended:
 1. Battery positive and negative cables should be as close to the battery as possible to minimize voltage loss and other possible effects.
 2. Tie, tape, or twist cables together to reduce self-inductance.
 3. Install all over current devices on the positive cable.

❖ AC wiring

CAUTION

Avoid switching on the inverter with the load (electronic devices) already switched on. This may trigger an overload since some electronic devices have an initial high power surge to start.

CAUTION

When switching off the inverter, turn off the electronic devices first. Although the inverter is off, the capacitors will still have a charge, so the DC and AC terminals must be disconnected if altering the circuitry.

CAUTION

Ensure all sources of DC power (i.e., batteries, solar, etc) and AC power (utility power or AC generator) are de-energized (i.e., breakers opened, fuses removed) before proceeding—to prevent accidental shock.

● **Steps:**

1. Remove the AC Terminal block.
2. Make note of the AC Input terminals from left to right (Neutral, Live, Ground).and the AC output terminals from left to right (Neutral, Live, Ground).

* If you want to connect the inverter to diesel generator or gasoline generator, gasoline generator, please follow these steps:

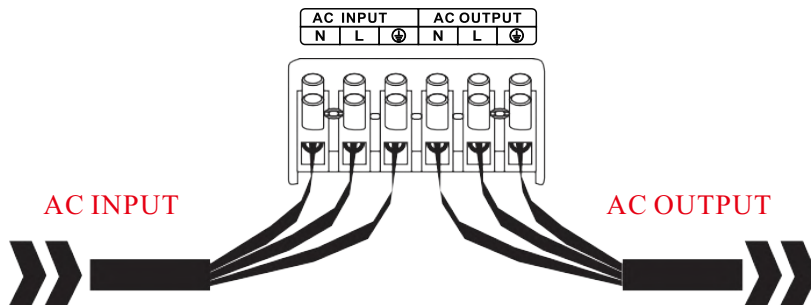

1. Turn on the generator, after it works stably, connect generator output to the inverter input(Confirm the inverter is no-load), then turn on the inverter as normal. After the inverter starts working, connect the load.
2. Recommended generator capacity is 2-3 times larger than that of the inverter.

WARNING

The AC input must NEVER be connected to the AC output as irreversible overload or damage may result.
AC Output should NEVER be connected to public power or a generator.

WARNING

This cannot be disabled.

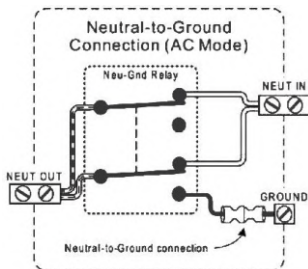

◆ **Automatic Transfer Relay**

The inverter chargers are equipped with transfer relay switch that switches between Inverter and Standby mode depending on availability of AC input power. if AC is present, the transfer relay bypasses up of the incoming AC power through the inverter to power the AC loads on the inverter's output. In the event AC power gets disconnected, the inverter will power the loads through the battery bank.

WARNING

The inverter's internal AC transfer relay contacts are rated for 30 amps (each leg), the pass-through current for relay contact must be no greater than 30 amps or damage to this relay may occur.

◆ **Dry Contacts for Auto Generator Start**

- To use this function, an auto start controller must be installed on the generator. There are three contacts; left to right: Normally Closed (NC), Common (COM), Normally Open(NO).
- When mains power is off, inverter uses the battery power to supply the load and the dry contact auto start.
- Do not store units with auto gen start feature enabled. Generators exhaust dangerous fumes when running.

◆ **Temperature Fault Auto Shutdown**

The operating temperature range for the inverter series is -10C°-50C° / 14F° - 122F°. If internal power components begin to exceed their safe operating temperature level, the inverter shuts down to protect itself from damage. It is required to manually restart the inverter when it cools down.

❖ FAN Operation

By default, when powering first, the unit fans and alarm will run for approximately 1 minute as part of the start-up routine. Other fan ON/OFF operation parameters are listed below:

Condition	Turn on Condition	Turn off Condition
Inverter Charger Uptime	Uptime \leq 1 minute	Uptime $>$ 1 minute
Inverter Mode Load Percentage	Load \geq 50%	Load $<$ 35%
DC Input Current	Current \geq 10A	Current $<$ 6A
Inverter Heat Sink Temperature	Temperature \geq 50°C	Temperature $<$ 45°C

❖ Connection diagram

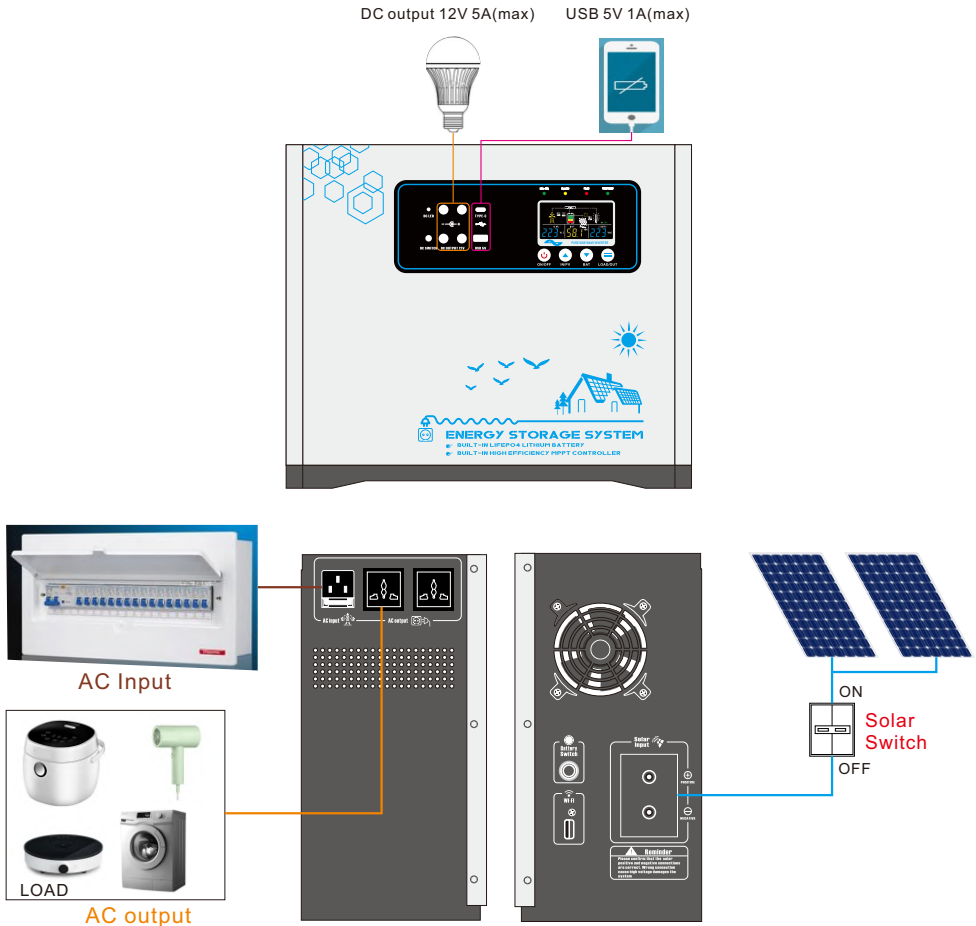

DC output 12V 5A(max) USB 5V 1A(max)

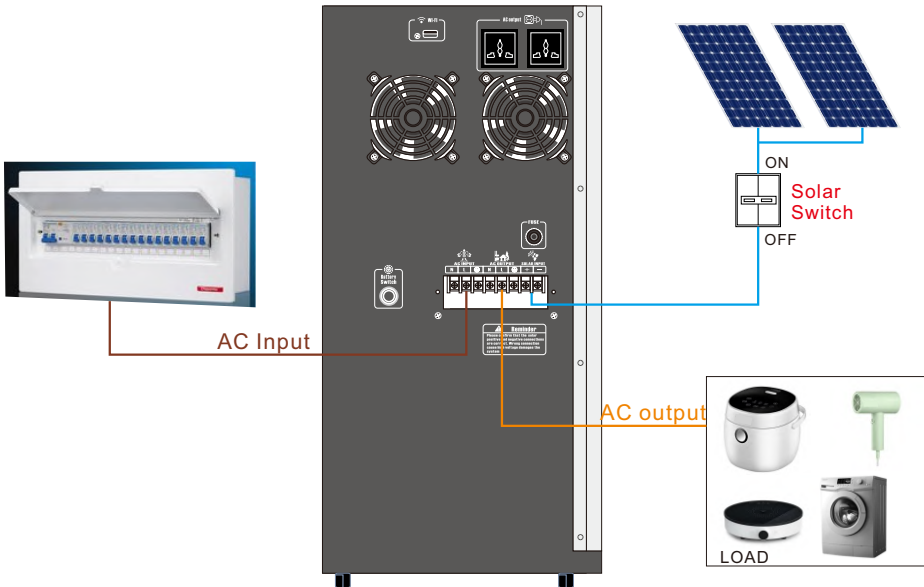
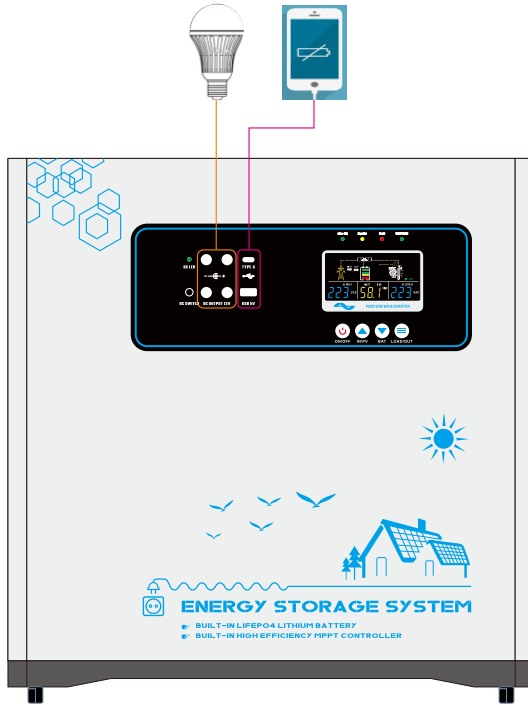

❖ Solar panel and battery connection diagram

◆ Solar panels in series

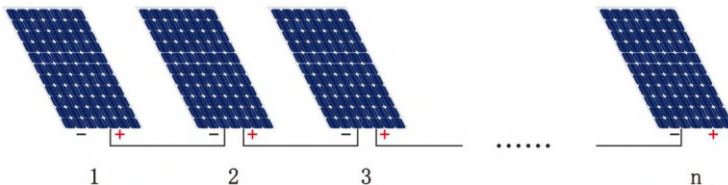

Solar panel $V_{Total} = V_1 + V_2 + V_3 + \dots + V_n$, the voltages of each solar panel are added together.

◆ Solar panel in parallel

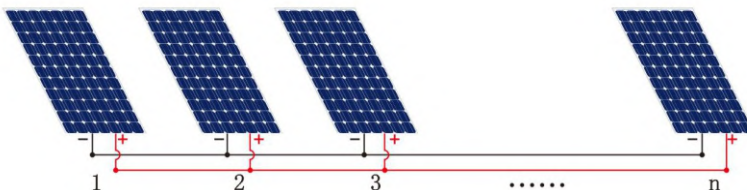

Solar panel $V_{Total} = V_1 = V_2 = V_3 = \dots = V_n$, the voltage of 1PCS solar panel (the voltage of each panel must be the same to be connected in parallel).

❖ LED indicator and LCD introduction

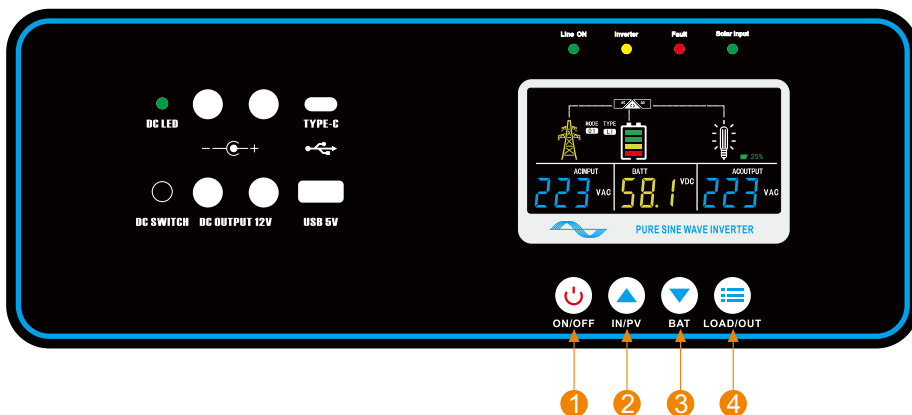









① Power switch

② AC Input / PV Query (Up)











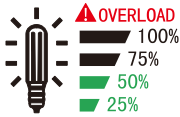

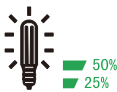
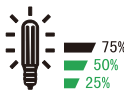
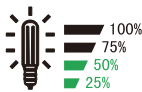

③ Battery Query (Down)

④ AC Output Query(Menu)

◆ **LED indicator**







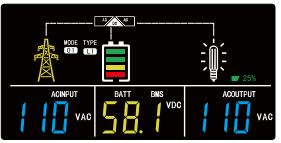

 Green Light (Line ON)	In the mains working mode, the LED light is on when the mains is working, the green light off when the inverter is inverting.
 Yellow Light (INT/ CHARGE)	1.Solid Battery is fully charged or inverter mode In the 03 battery priority mode, the PC menu determines whether the light is ON or OFF during charging. 2.Flashing Battery is charging (Mains Charging Indicator: It will OFF when charging is completed).
 Red Light (Fault/ Overload)	1.Flashing when the overload is more than 110%, lights flashing when the battery is low 2.Solid when the inverter fails.
 Green Light (Solar input)	When there is solar power input, LED light will be ON, without solar power LED light will be OFF.
 ON/OFF	Hold 3-5 seconds to turn on the inverter and buzzer will sound. Hold 3 seconds to turn off the inverter.
 IN/PV	Press the PV/IN key to query AC Input and PV information.
 BAT	Press the BAT key to query Battery information.
 LOAD/OUT	1.Press3-5 seconds to enter the inverter setting page parameter. 2.Press to confirm setting in parameter setting. 3.Tap to query AC output and load information.

◆ LCD info

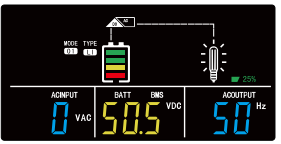
Load Information				
OVER LOAD	Indicates overload. Indicates the load level by 0-25%, 26-50%, 51-75% and 76-100%			
	1-25%	26-50%	51-75%	76-100%
				
Inverter Operation Information				
	Indicates unit is connected to shore power.			
	Indicates load is supplied by utility power. Indicates the utility charger circuit is working.			
	Indicates the DC/AC inverter circuit working.			
	Indicates the activation of the buzzer.			
	Indicates that the device is enabling WI-FI communication.			
	Indicates that the device is enabled for Bluetooth communication.			
MODE 	Indicates the current working mode.			
TYPE  	Indicates the current battery category or USE.			
Solar Operation Information				
	Indicates that there is currently solar input			
MODE 	Indicates the current working mode of solar energy.			

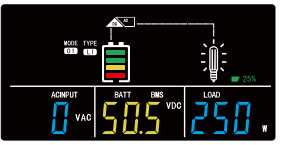
Battery Information	
Battery voltage(Single)	Battery capacity percentage
14.00V	100%
13.30V	100%
13.00V	90%
12.60V	80%
12.40V	70%
12.20V	60%
12.00V	50%
11.80V	40%
11.60V	30%
11.40V	20%
11.20V	10%
10.00V	0%

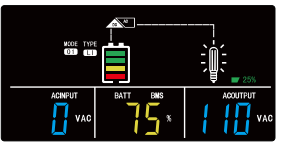
◆ LCD information

	Inverter mode: No mains input, only connect to battery:		Mains mode: (battery capacity icon flashing when AC charging)
	03: Battery priority mode, mains status (mains icon will flash)		50Hz/60Hz: Frequency display (Automatic)
	LOAD***%: Load % display		LOAD ***W: Load power display
	Overload display: (Over Load icon will flashes)		BATT***%: Battery % display
	BATT**V: Battery voltage display		AC OUTPUT: 0.0KWH: Accumulated power generated by the inverter display

◆ Hybrid solar input information

	Solar input with mains		Solar input without mains
	PV ***V: Solar input voltage display		PV ***A Solar input current display
	PV ***W: Solar input power display		PVT 0.0KWH: Real time solar power generation power display
	PVD 0.0KWH: Accumulated solar power generation display		

◆ Information Service

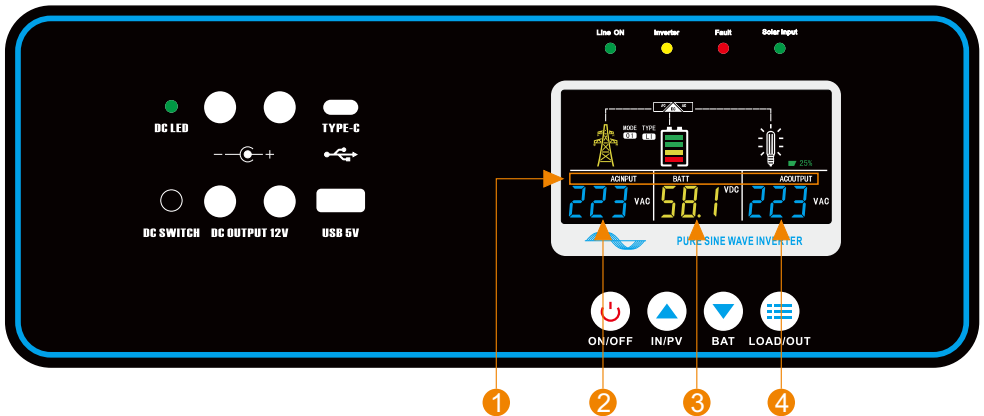

- ① Query information items
- ② PV, AC input data
- ③ Battery data
- ④ AC output ,LOAD data

- **The operation is as follows:**

- ▶ Press the **PV/IN** key to query PV, AC input data information:

- 1) PV information (PV):

- 1. PV input voltage, PV input current, PV input power.

- 2. Daily power generation of PVT

- 3. Total power generation of PVD

- 2) AC input information (AC INPUT):**

- AC input voltage, AC input frequency

- ▶ Press the **BAT** key to query Battery, BMS data information:

- 1) Battery information (BATTERY):

- Battery voltage, battery percentage, charging current

- 2) BMS information (BMS):

- Battery voltage, battery discharge current, battery charge current, cell voltage, battery temperature.

- ▶ Press the **LOAD/OUT** key to query AC output, LOAD data information:

- 1) AC output information (AC OUTPUT):

- AC output voltage, AC output frequency

- 2) Load information (LOAD):

- load power, load percentage

- **Shortcut key:**

- 1) Under normal display, Changan BAT switches between 01,03 and 06 modes.

- 2) Under normal display, press and hold Pv/IN and BAT buttons simultaneously to clear accumulated power generation.

❖ parameter setting

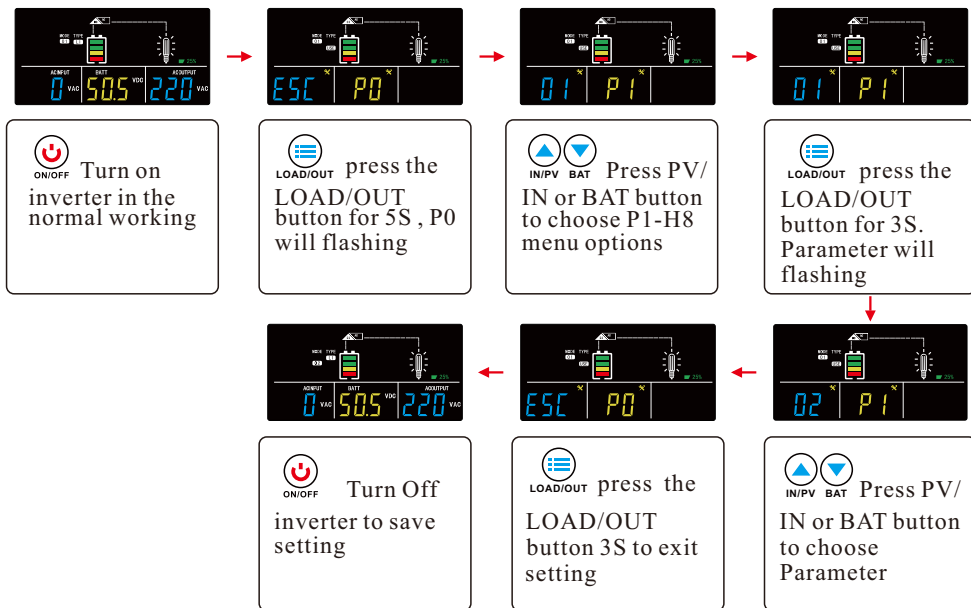

1. When the inverter in the normal working.
2. press the LOAD/OUT button for 5S to enter the setting menu. Enter the setting menu, LCD shows the working mode icon is flashing.
3. Press the PV/IN button or the BAT button to operate the menu options. The working mode icon will change depending on the operation.
4. When choose the right menu option, press the setting button LOAD/OUT 3S to enter the setting parameters, (At this time, the working mode icon is not flashing, in the left parameter item is flashing.)
5. Press the up or down button to select the setting parameter, press the LOAD/OUT button 3S to exit the setting. (At this time, the working mode icon flashes, and the parameter icon does not flash.)
6. To exit the mode (ESC), press the LOAD/OUT button 3S to enter the set parameters and then press the LOAD/OUT button 3S to exit the setting menu and save the settings.
7. Need to press the ON/OFF button to save parameters Setting.

8. Quick setting of working mode: Long press the scroll BAT button to switch between 01, 03, and 06 working modes

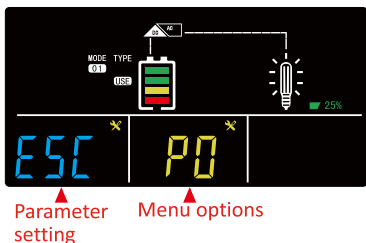

P0: Set work mode menu:
Press the LOAD/OUT button 3S to enter the setting menu, the menu selection icon is flashing. If need save and exit, press the LOAD/OUT button 3S to save and exit.

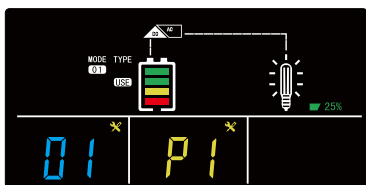

P1: work mode setting:
01: Mains priority mode
02: Energy saving mode
03: Battery priority mode
04: Mains priority Unattended mode
05: Battery priority Unattended mode
06: Solar priority mode

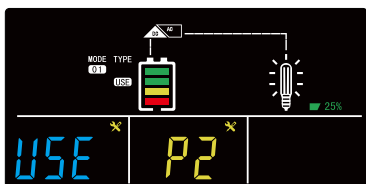

P2: Battery type and charging voltage setting:
SLD: lead-acid battery (default), FLD: FLD battery, GEL: gel battery, LI: lithium battery, USE: user mode. Select USE user mode to adjust battery voltage in P3 and P4 menus. If you do not select the USE user mode, the P3 and P4 menus will not appear.

Battery type	uniform charge voltage (Single section)	floating charge voltage (Single section)
Lead-acid battery	14.4V	13.6V
FLD battery	14.8V	13.2V
Gel battery	14.4V	13.7V
Lithium battery	14.5V	13.5V

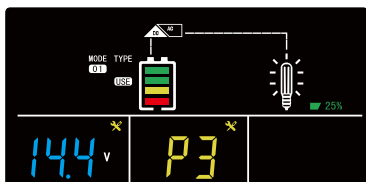

P3: Battery voltage uniform charge setting:
12.5V ~ 15.5V (single) can be set.

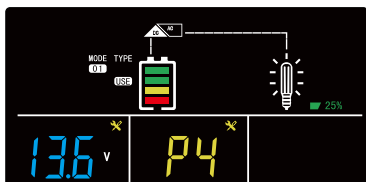

P4: Battery voltage floating charge setting:
12.5V ~ 13.9V (single) can be set.

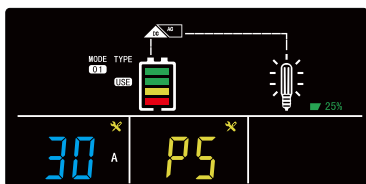

P5: Maximum mains charging current setting:
(For details, refer to the label of the corresponding machine on Page 32)
5A, 10A, 20A,30A,40A,50A.

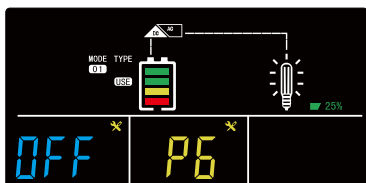

P6: Buzzer sound setting:
ON: Turn on the buzzer, OFF: Turn off the buzzer (over voltage, under voltage, overload, over temperature, except faults).

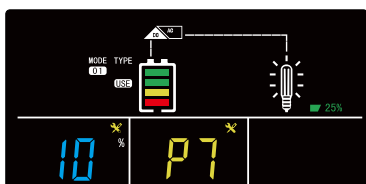

P7: Energy saving mode AC output setting:
(10% default), in (USE) user mode, can be adjusted up and down 1.0-10% /1%.

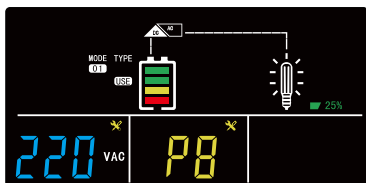

P8: Inverter output voltage setting:
220V default, (208V, 210V, 220V, 230V, 240V)
110V default, (104V, 105V, 110V, 115V, 120V).

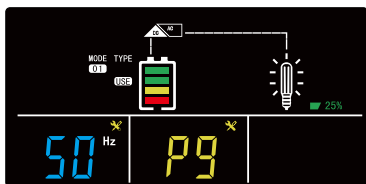

P9: AC Output frequency setting:
50Hz default, (50Hz, 60Hz).

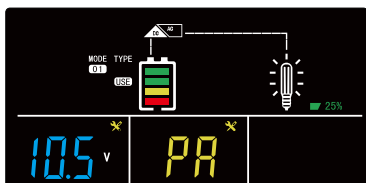

PA: Solar priority mode, battery under voltage to mains voltage setting:
10.5V default(10.5V- 12.8V can be set. (0.1 increment)).

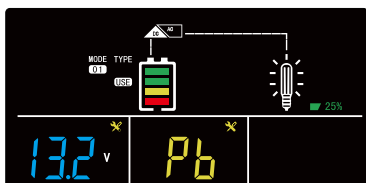

Pb: Solar priority mode, when battery voltage is restored, the inverter is disconnected from the city power.
Conversion inverter Voltage:
13.2V default, (12.4V ~ 14.4V) can be set.

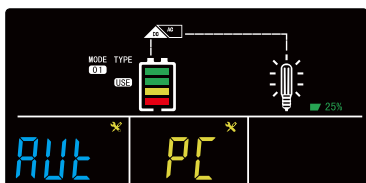

PC: battery priority mode, mains is charged or not:
Aut default, ON (battery priority with AC charging), OFF (battery priority without AC charging), Automatic (Only the inverter with built-in solar controller can make this function work, detection solar priority or city power priority, select solar charging, the mains will charge when the solar charging current is small) The specific charging method is as follows:

The relationship between solar charging and mains charging:	
Solar charging current	Mains charging current (* maximum set charging current)
40A	0%
30A	20%
20A	40%
10A	60%
5A	80%
0A	100%

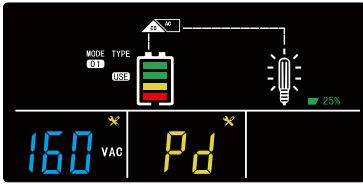

Pd: AC input lowest voltage setting:

AC220V: Default 160VAC, (140V, 150V, 160V, 170V, 180V,190V).

AC110V: Default 80VAC, (70V, 75V, 80V, 85V, 90V,95V).

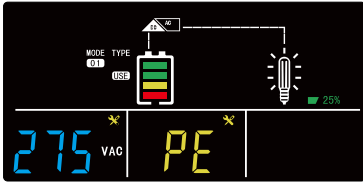

PE: AC input highest voltage setting:

AC220V: Default 275V, (260V, 265V, 270V, 275V, 280V, 285V, 290V).

AC110V: Default 137V, (130V, 132V, 135V, 137V, 140V, 142V, 145V).

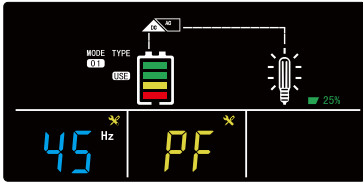

PF: AC input minimum frequency setting:

Default 45Hz, (40Hz, 41Hz, 42Hz, 43Hz, 44Hz, 45Hz).

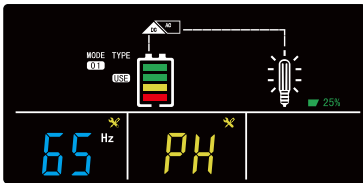

PH: AC input maximum frequency setting:

Default 65Hz, (63Hz, 64Hz, 65Hz).

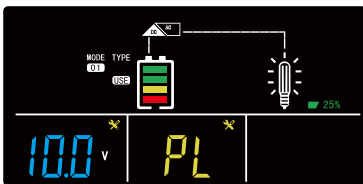

PL: Battery low voltage shutdown setting:

(must: $P_n > P_L > F_4$)

10.0V default, 9.5V ~ 12.5V can be set.

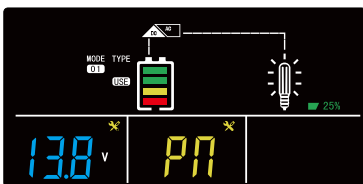

Pn: unattended mode, battery under voltage restores the startup voltage setting:

(must: $P_n > P_L > F_4$)

13.8V default, 11.2V,11.4V,11.6V,11.8V,12.0V, 12.2V,12.4V,12.6V,12.8V,13.0V,13.2V,13.4V, 13.6V,13.8V,14.0V,14.2V,14.4Vcan be set.

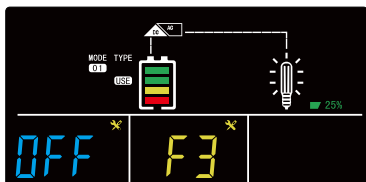

F3: Generator mode setting:
Default OFF (ON \ OFF).

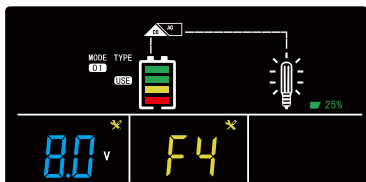

F4: Unattended mode battery voltage low power off power point setting:
(must: $P_n > P_L > F_4$)
8.0V default, 8.0V, 8.2V, 8.5V, 8.7V, 8.9V, 9.0V, 9.2V, 9.5V can be set.

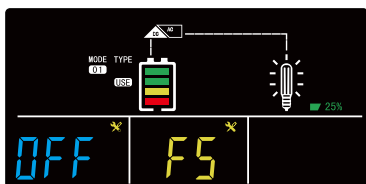

F5: Fan failure detection settings:
Default single block OFF (ON, OFF).

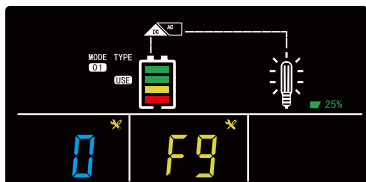

F9: Dry contact type detection setting:
Default 0, (0: Whether the mains power is normal dry contact, 1: whether the battery is low battery dry contact).

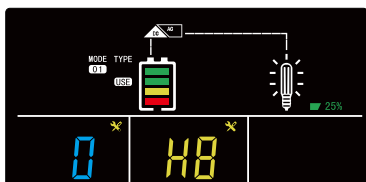

H8: BMS current accuracy setting
Default 0, (0: BMS current without decimal point display accuracy 1, 1: BMS current with decimal point display accuracy 0.1).

❖ Fault code and repair

- This icon  will flash when there is a fault.

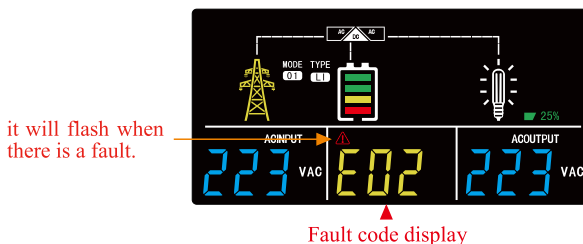

Code	Buzzer or indicator	Fault cause	Solution
E01	Keep shouting, red light keep lighting	Battery low voltage	Check the battery is broken or not
E02	1 long 2 short B-BB shout, red light is off	Battery overvoltage	Check the battery is broken or not
E03	Buzzer Buzzer sounding the red light keep lighting	Battery low voltage	Check the battery is broken or not
E04	Intermittent Buzzer sound, red light is off	Transformer secondary line reverse connection	Restart or contact the supplier
E05	Buzzer sounding, red light keep lighting	Inverter startup failure	Check output have circuit, overload or not
E06	Buzzer sounding, red light keep lighting	Output for short circuit	Check output have circuit, overload or not
E07	Buzzer sounding, red light keep lighting	Output voltage is too low or overloaded	Check output voltage and load
E08	Buzzer sounding, red light keep lighting	Temperature is too high	Check the fan is working
E09	Output Low voltage	Battery low voltage overload	Check the battery is broken or not Reduce load

E11	Buzzer sounding, red light keep lighting	Low temperature or temperature control failure	Check the temperature control lines are not open circuit , dropped
E14	Buzzer sounding, red light off	Fan open circuit	Check the fan are not open circuit , dropped
E15		Input relay short circuit	Tap the input relay to check if broken or not
E16	Buzzer sounding, red light keep lighting	The mains power is turned on, and the mains power input voltage is too high	Reduce input voltage
ES 0	Displayed when you press the controller display page	Controller work well	Controller work well
ES 3	Displayed when you press the controller display page	Controller over current	Internal fault
ES 4	Displayed when you press the controller display page	Controller temperature high	Internal fault
ES 5	Displayed when you press the controller display page	Solar input over voltage	Check Solar input voltage and correct number of solar panels
ES 6	Displayed when you press the controller display page	Solar input low voltage	Check Solar input voltage whether solar panels have not damaged

Controller fault codes			
codes	Buzzer or indicator	Fault cause	Solution
F10		The controller internal temperature is too high	Check if the fan works after the temperature drops
F20		The controller fails to automatically identify the battery level.	Disconnect the battery to check if the battery voltage is correct and then reconnect it
F30		Solar input voltage is too high	Check whether the solar input voltage is correct
F50		Battery voltage is high	Disconnect and check if the battery voltage is correct
F60		Battery voltage is low	Disconnect and check if the battery voltage is correct
F70		DC output overcurrent	Check whether there is a short circuit in the DC output load, remove the load and then reconnect it

❖ buzzer alert

Buzzer sound:

- 1) Inverter: A beep sounds every 10 seconds. 10S --- 10S ---
- 2) When the battery voltage is low, one sound per second. --1S--1S--
- 3) When the battery is high voltage: three sound every four seconds, one long and two short. 4S -----
- 4) Overload:
 - > 110% long sound. ----
 - > 105% sound every two seconds. 2S --- 2S ---
- 5) Temperature control failure: 2 sound every 4 seconds 4S---4S---
- 6) The temperature is too high: sound every two seconds. 2 --- 2 ---
- 7) Fan abnormality: long sound ---

❖ Specifications

Inverter Specifications					
Model	MPSG-N500	MPSG-N1000	MPSG-N2000	MPSG-N3000	MPSG-N5000
Surge Power (1 second)	1500W	3000W	6000W	9000W	15000W
Surge Power (10 seconds)	650W	1300W	2600W	3900W	6500W
Surge Power (60seconds)	550W	1100W	2200W	3300W	5500W
Commercial Power Range	110VAC/120VAC (Optional)		220VAC/230VAC/240VAC (Optional)		
AC Frequency Range	45-65HZ				
Selectable Voltage range(VAC)	110VAC,120VAC,220VAC,230VAC,240VAC±10% (Auto-sensing)				
Output Frequency Range(AC mode)	Tracking automatically /shared frequency with the commercial inversion state:60/50±0.5 Hz				
DC Voltage Input	12.8VDC	25.6VDC			51.2VDC
Input Wave Form	Sine Wave (Utility or Generator)				
Output Wave Form	Pure Sine Wave				
Output Overload	105% < Load < 110% ± 10% : Fault (Turn off output after 60 seconds) 110% < Load < 130% ± 10% : Fault (Turn off output after10 seconds) 150% < Load ± 10% : Fault (Turn off output after 1 seconds)				
Thermal Method	cooling fan in intelligent control is≤42 °C, fan rotates slowly to ≥ 45 °C or the load is ≥ 50%, and the fan rotates fast				
Communication port	WiFi / Bluetooth (Optional)				
temperature	-10°C ~ +50°C				
Humidity	10% ~ 90%				
Short Circuit Protection	Software Protection				
Line Mode Efficiency	> 95%				
Optimal Efficiency	>85%				

DC Battery Specifications

Model		MPSG-N500	MPSG-N1000	MPSG-N2000	MPSG-N3000	MPSG-N5000
AC Charging (Max)	12.8V	10A	-----	-----	-----	-----
	25.6V	-----	20A	40A	40A	-----
	51.2V	-----	-----	-----	-----	50A
Battery Type		LiFePO4				
Battery capacity		602Wh	1180Wh	2560Wh	2995Wh	5120Wh
Floating Charge Set		13.6V	27.2V			54.4V
Low Voltage Shutdown set		10V	20V			40V
Charge termination Voltage		14.6V	29.2V			58.4V
Transfer Time		Typical: 5-8ms(Including detection time)				
Waveform		Pure sine wave				

solar charge controller

Model		MPSG-N500	MPSG-N1000	MPSG-N2000	MPSG-N3000	MPSG-N5000
Max Solar Charger Current		20A	20A	30A/60A	60A	60A
Battery DC Voltage		12.8VDC	25.6VDC			51.2VDC
PV Voltage Input Range		90VDC (Max)		130VDC (Max)	160VDC (Max)	
Max PV Power Input	12.8V System	20A:256W				
	25.6V System	20A:512W,30A:768W,60A:1536W				
	51.2V System	60A:3072W				

