















Security matters

	<h3>Compliance and standards</h3>
<p>This equipment meets the following INVreference standards:</p> <p style="text-align: center;">IEC 609501, IEC 620401-1 use operating area general safety requirements</p> <p style="text-align: center;">IEC / EN 62040-2 EMC Requirements</p> <p style="text-align: center;">IEC 62040-3 performance requirements and test methods</p> <p>Equipment installation shall be according to the above requirements and use the accessories specified by the manufacturer.</p>	
 	<h3>warn</h3>
<p>Large ground drain current: ground reliably before accessing the input power (including AC main and battery). The grounding of the equipment must comply with the local electrical regulations.</p>	
 	<h3>warn</h3>
<p>The selection of advanced power distribution protection equipment for the INVsystem must comply with the local electrical regulations.</p>	
 	<h3>warn</h3>
<p>INVinternal insurance is damaged and must be replaced with the same electrical parameters and operated by professional personnel.</p>	
 	<h3>take care</h3>
<p>This device is equipped with a radio frequency interference (RFI) filter.</p> <p>The opposite floor drain current is between 3.5 m A and 1,000 m A.</p> <p>When selecting a transient leakage current circuit breaker (RCCB) or other leakage detection instrument (RCD), the transient and steady-state pair of ground leakage current may be considered. An RCCB that is insensitive to the unidirectional DC pulse (Class A) and transient current pulses must be selected.</p> <p>Note that the loaded pair of floor drain current will also flow through the RCCB or RCD.</p>	
 	<h3>warn</h3>
<p>The system provides a signal used with an external automatic switch to prevent the inverter voltage back to the input via the main static bypass circuit. If this protection feature is not used with the switchgear used to isolate the bypass circuit, it must be labeled to show that the maintenance staff understands that the circuit is connected to the INVsystem.</p> <p>Above means: Please isolate the INVbefore operating this circuit.</p>	
 	<h3>General safety</h3>
<p>Like other types of high-power equipment, the INVand battery case contain high pressure inside. However, since the components with the high pressure can only be contacted by opening the front door (locked), the possibility of contacting the high pressure has been minimized. The equipment also has other internal security shielding, in accordance with the IP20 standard. Follow the equipment following the steps recommended in this book. All equipment maintenance and maintenance involve contact with internal components and must be performed by trained personnel.</p>	
 	<h3>cell</h3>
<p>The battery manufacturer provides the precautions to be observed when using large sets of batteries or near them, which should be observed at any time. Special attention should be paid to the relevant suggestions on local environmental conditions and the provision of protective overalls, first aid equipment and fire fighting equipment.</p>	

catalogue

- summary.....1
 - characteristic.....1
 - design philosophy.....1
 - ◆ system design.....1
 - ◆ bypass.....1
 - ◆ ECO mode (for optional INVPC only).....2
 - ◆ INV power switch configuration.....2
 - ◆ battery switch.....2
 - ◆ System Expansion (optional only).....2
 - running mode.....3
- Mechanical Installation.....4
 - matters need attention.....4
 - Environmental Requirements.....4
 - ◆ INVbit selection.....4
 - ◆ Position selection of the battery.....5
 - Mechanical Requirements.....5
 - ◆ system composition.....5
 - ◆ The movement of the cabinet.....5
 - ◆ operating spac.....5
 - ◆ line approach.....5
 - initial survey.....5
 - installation drawing (physical drawing).....5
- electrical installation.....7
 - power cable wiring.....7
 - ◆ system configuration.....7
 - ◆ Cable Specifications.....7
 - ◆ General considerations.....7
 - ◆ Cable connection terminal.....7
 - ◆ dependency.....7
 - ◆ protector.....8
- Operation Control Display Panel.....9
 - introduce.....9
 - ◆ alarm buzzer.....10
 - ◆ Type of LCD display.....10
 - ◆ Operation Guide for LCD display.....11
 - ◆ fault and alarm code sheet.....12

- INValarm information list15
 - Introduction to INVoperation15
 - installation and trial run15
 - ◆ boot step15
 - ◆ Shutdown Step15
 - ◆ mains switch15
 - INVstartINVtep (enter inverter supply)15
 - INVStart Steps (into Economic Mode)16
 - Battery Test Procedure17
 - service bypass operation procedure (INVShutdown Step)17
 - Shutdown Step (close INVand load completely)18
 - Emergency Stop (EPO) Procedure18
 - INVreset procedure18
 - auto-start19
 - Battery19
 - brief introduction19
 - safe19
 - INV Battery19
 - Installation Design Notes19
 - battery mounting environment and battery count20
 - ◆ installation environment20
 - ◆ Number of batteries20
 - Battery Protection20
 - battery connection21
 - ◆ Battery assembly21
 - ◆ Battery wiring21
 - Installation of battery21
 - Battery Temperature Transmitter (option)21
 - Battery recycling26
 - Maintenance and Maintenance21
 - ◆ Replacement Insurance22
 - identification table of toxic and harmful substances or elements23

summary

This chapter briefly introduces the characteristics, design idea and operation mode of three incoming and three outgoing INV.

characteris

Power frequency machine three in and three out of the UPS connection between the three-phase input power supply and the important load (such as the computer), for the load Provide a high-quality three-phase power supply

The INVhas the

1. Improve the power supply quality	The INVuses internal voltage and frequency modulators that protect its output from changes in its input power supply.
2. Improve noise suppression	Due to the AC-DC-AC transformation mode, the clutter in the input power supply is effectively filtered out, so that the load can get a clean power supply.
Municipal power, power loss protection	If the input power is off, the INVis powered by the battery and the load supply is powered without interruption.

design philosophy

system design

This section introduces the working principle of three in and three out INValone. The AC-DC-AC converter is used for the three-in and three-out INV. The first-stage transformation (AC-DC) adopts the SCR three-phase full-control bridge rectifier to transform the three-phase AC input voltage into a stable DC bus voltage.

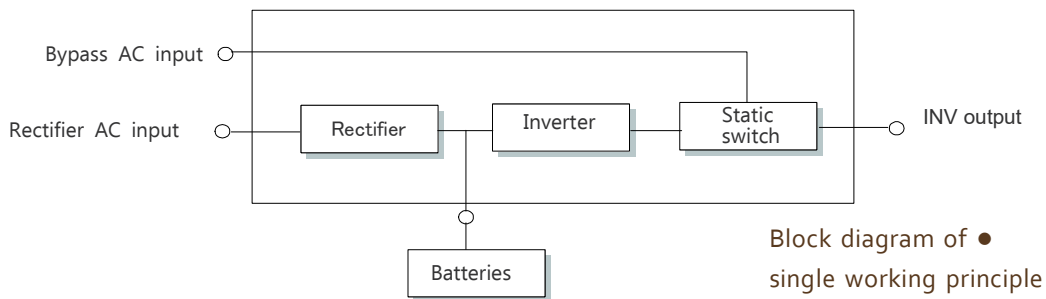

Block diagram of • single working principle

The rectifier and the charger function, and adopts the industry's advanced temperature compensation technology, can effectively prolong the battery life. The main power of the inverter adopts the high-power insulated gate bipolar transistor (IGBT) as its inverter element, and the advanced space vector pulse width modulation (SVPWM) technology is used to reverse the DC bus and voltage back to the AC voltage. When the mains is normal, the rectifier and the inverter work at the same time to power the load while charging the battery. When the city power is abnormal, the rectifier stops working and turns from the battery to the load through the inverter; if the battery voltage drops to the discharge termination voltage and the city power is not restored to normal, the INVwill shut down (if the main side of different sources and the bypass is normal, the system turns to the bypass power supply). The time when the battery maintains the INVoperation until the battery voltage drops to the battery discharge termination voltage and turns down is called the "backup time". The length of the backup time depends on the capacity of the battery and the size of the load.

bypass

The intelligent control of the "static switch" module containing a controllable electronic switching circuit enables the load to be powered by both an inverter or a bypass power supply. Under normal circumstances, the load is powered by the inverter, when the static switch on the inverter side is closed; when the overload occurs (overload time to) or the inverter fault occurs, the "static switch" module automatically switches the load to the bypass power supply.

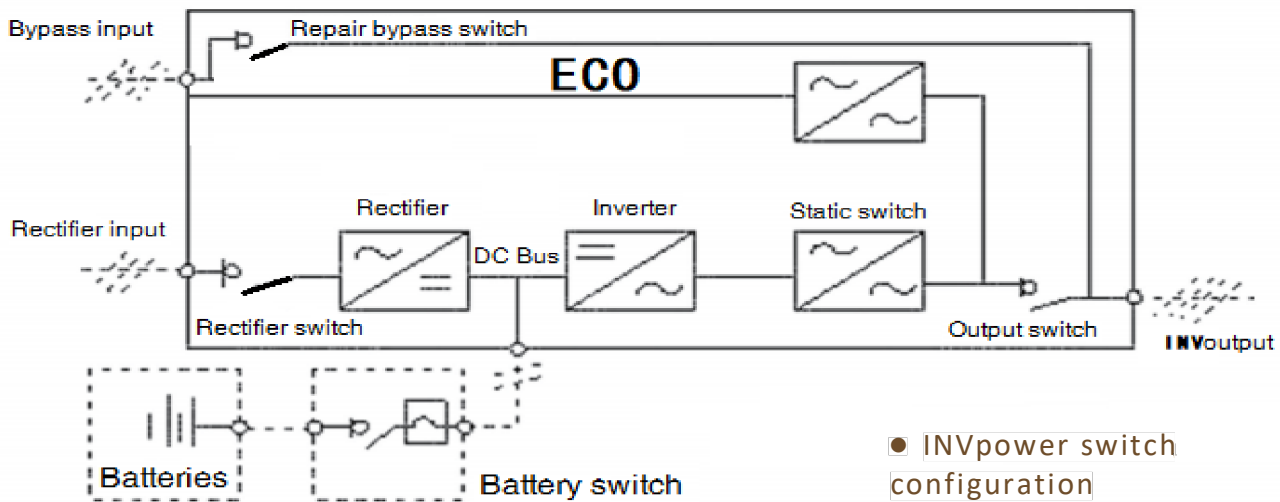

In the normal operation state, in order to realize the uninterrupted switch between the inverter and the bypass power supply, we must control that the inverter output and the bypass power supply must be fully synchronized. In view of this, when the bypass power supply frequency is in the synchronous range, the inverter control circuit always causes the inverter output frequency to track the bypass power supply frequency. In addition, the power frequency machine three in and three out of the INV also set up the manual maintenance bypass switch, used for the INV needs to be shut down due to maintenance, by the bypass power supply through the manual maintenance bypass switch directly to the important load power supply.

Note: When the load is powered by the bypass or the maintenance bypass, the power supply cannot be guaranteed accordingly.

ECO mode (for optional INV PC only)

In economic (ECO) mode, the load is preferentially powered by mains bypass and the inverter is in standby state. When the mains exceeds the standard range of frequency and voltage values (set when available), the load is switched back to the inverter supply state.

If ECO mode is required, this function should be selected during ordering and modified during production.

The operation method of the ECO mode is the same as that described in the INV operation, but under normal circumstances, the load is powered by the bypass mains, when the inverter power supply indicator light is off, and the corresponding operation mode shows as "bypass power supply".

	<p>warn</p> <p>In ECO mode, the load is not protected by the electric voltage distortion.</p>
---	--

INVpower

The description is the block diagram of three in and three out INV single machine with "separate bypass power supply". In a separation bypass, a static bypass and a maintenance bypass jointly use a separate bypass power supply. If there is no separate bypass power supply, short connect the input of the bypass switch and the input switch (the standard model has been short connected here) to make the bypass input and rectifier input use the same road mains. During normal INV operation, all other switches shall be closed except to repair the bypass switch.

Battery

The battery is connected to the DC bus through the battery switch at 10-80K. The 100-400K model battery switch selections. The battery switch is manually closed. The battery switch has the overload protection tripping function. When the current between the DC bus and the battery pack is too large, the battery switch will automatically trip.

System

The customized INV system can connect up to 6 INV units in parallel, and meet the greater load power supply requirements through the capacity expansion. When the system expands, the setting of each single-machine operation control display panel should be changed accordingly.

Note: The expansion of the system can be performed only by the relevant trained maintenance personnel. When expanding the capacity, the capacity of each single unit must be the same.

Optional system expansion must be informed to the manufacturer upon ordering.

running mode

The INV can run in one of the following operating modes:

Municipal power supply and inverter power supply mode

main is first rectified by INV rectifier, and then converted by inverter to provide continuous and uninterrupted AC power supply for the load. At the same time, the charger (rectifier and both) charges the battery with floating charges or both charges.

Battery mode

The battery operation mode through the inverter inverter to provide the backup power to the load is the battery mode. When mains power is cut, the system automatically turns to battery mode, and the load power supply will not be interrupted. Thereafter, when the mains power supply is restored, the system will automatically switch back to the mains inverter power supply mode, without any manual intervention, and the load power supply will not be interrupted.

Automatic boot-up mode

INV provides automatic boot function, that is, the mains outage time is too long, the battery discharge to the termination voltage will automatically shut down the inverter, if the mains resumes power supply, INV will automatically start up.

Bypass mode

The load is powered by a static bypass mains power supply. This power supply mode can be regarded as an intermediate power supply mode between the inverter power supply and the maintenance bypass power supply, or a power supply mode in the abnormal working state.

Repair bypass mode

The INV is off and the load is directly connected to the bypass power supply via the service bypass switch. Power comes from the bypass input power supply to the load.

(Optional) Joint power supply mode

INV provides a joint power supply operation mode, allowing the restrictive use of AC mains input power supply, while fully meet the load power supply requirements, the load power supply part is provided by the battery. This function is applicable to the implementation of high electricity charges during the peak power consumption period, or when the oil machine is not enough to meet the load power supply requirements of the municipal power failure. The combined power supply mode can be set by the user, and the load power supply ratio of the mains power input ranges from 20% to 100% of the rated output.

(Optional) Economic (ECO) mode (for PC systems only)

INV provides a joint power supply operation mode, allowing the restrictive use of AC mains input power supply, while fully meet the load power supply requirements, the load power supply part is provided by the battery. This function is applicable to the implementation of high electricity charges during the peak power consumption period, or when the oil machine is not enough to meet the load power supply requirements of the municipal power failure. The combined power supply mode can be set by the user, and the load power supply ratio of the mains power input ranges from 20% to 100% of the rated output.

(Optional) Parallel redundancy mode (system expansion)

In order to improve the system capacity or reliability, or both improve the system capacity and system reliability, several INV units can be set directly in parallel, by the parallel control logic in each INV unit to ensure that all units automatically evenly divided load. The parallel machine system can be composed of up to 6 single machines in parallel.









(Optional) Frequency converter mode

The INV may be set to a frequency converter mode, providing a stable output frequency of 50Hz or 60Hz. The input frequency range ranges from 45 Hz to 65 Hz. In this mode, the bypass switch is required to be disconnected, the static bypass is invalid, the battery is optional, and determine whether to choose the battery according to whether the battery mode operation is required.

▲ Mechanical installation

This chapter briefly describes the mechanical installation of the three or three series of INV, including the precautions, environmental requirements, mechanical requirements, pre-installation initial inspection and installation drawings, etc.

matters

  warn	  warn
Before the authorized engineer to debug the INV, be sure to keep the dust cover on the top of the INV to prevent dust accumulation in the machine from causing system failure or personal danger during installation.	Please do not power the INV until the authorized engineer arrives.
  warn	  Warning: Battery hazard
The INV shall be installed by qualified engineers as described in this chapter. All other equipment not covered in this manual is shipped with its detailed mechanical and electrical installation information.	Battery installation requires special care. When connecting the battery, the battery end voltage will exceed 400Vdc, which is fatal. <ol style="list-style-type: none"> 1. Please wear eye shields to avoid accidental arc damage to the eyes. 2. Take off all the metal wearing objects, such as rings and watches. 3. Use tools with an insulated handle. 4. Wear rubber gloves. 5. If the battery electrolyte leakage or battery damage, the battery must be replaced, placed in a sulfuric acid-resistant container, and scrapped according to local regulations. 6. If the skin comes into contact with the electrolyte, rinse with water immediately.
 warn	
The INV system can be connected to the neutral ungrounded power system (i. e., the IT system).	

This chapter describes the environmental and mechanical requirements that must be considered in the selection and routing of the INV. Because each site has its own particularity, this chapter does not introduce the detailed installation steps, but only provides guidance on the general installation steps and methods for the installation personnel, which are handled by the installation personnel according to the specific situation of the site.

▲ Environmental requirements

Selection of the INV bits

The INV shall be installed in a cool, dry, clean and well ventilated environment. Environmental dust should not contain conductive dust (such as metal powder, sulfide, sulfur dioxide, graphite, carbon fiber, conductive fiber, etc.), acid fog or other conductive media (strong ionizing substances). The specific environmental indicators shall meet the requirements of relevant national standards and specifications and the indicators specified in this manual.

The three-in and three-out INV is provided by the internal fan. The cold air enters the INV through the air grille of the INV cabinet and is discharged through the wind grille of the INV. If the INV is installed on the elevated floor and adopts the bottom line approach, the cold air can also enter the INV through the gap in the floor. If necessary, an exhaust fan should be installed to accelerate the ambient air circulation. In the more dust environment, the air filter device should be installed.

Note 1: When the battery cabinet is installed near the INV, the maximum allowable ambient temperature is determined by the battery, not by the INV.

Note 2: When INV works in ECO mode, the power consumption is relatively small; while working in inverter power consumption, the appropriate air conditioning system should be selected according to the power consumption in inverter power supply mode.

The

Ambient temperature is the main factor affecting the battery capacity and life. The standard operating temperature of the battery is 20°C, above the ambient temperature of 20°C, which will shorten the battery life, and below 20°C will reduce the battery capacity. Usually, the allowable ambient temperature of the battery is between 15°C and 25°C. The ambient temperature of the battery should be kept constant, and the battery should be kept away from the heat source and the main vent.

The battery may be installed in a dedicated battery cabinet, which shall be close to the INV. If the battery is placed on the elevated floor, supports should be mounted under the floor as in the INV. If the battery is installed on the battery rack, or in other ways, far away from the INV, the battery switch should be installed as close to the battery as possible, with the shortest walking distance as possible.

▲ Mechanical requirements

system

According to the different design requirements of each INVsystem, a INVsystem can include several equipment cabinets, such as: INVcabinets, battery cabinets, etc. 300kVA INV(12 Pulse rectifier) and the 400kVA INVcabinet include the main cabinet and the side cabinet. Usually, all cabinets are of the same height and are mounted side by side for aesthetic results.

The



warn

The lifting equipment used to move the INVcabinet must have sufficient lifting capacity. Ensure that the INVweight is within the load capacity of the lifting equipment.

The INVcabinets can be handled by a forklift truck. Before handling, the front, rear (or side) of the cabinet should be removed.

If forklifts cannot be used for handling, use rollers, etc.

operating

Since the INVabove 100K has no wind grille on the side and behind, there is no special space requirement for the side and behind, but if the space permits, keeping about 1000mm will facilitate the operation of the rear magnetic element. Adequate operation space should be kept in front of the INV. After the INVdoor is fully opened, people can pass freely. Behind 10K to 80K, please a space of about 500mm to facilitate heat dissipation and power switch operation.

Into the

Power frequency machine three in and three out INVand battery cabinet can adopt the bottom line mode and the rear bottom surface line mode.

When using the front bottom entry line, open the front door and remove the lower panel baffle to see the side entry hole.

If the rear bottom line approach is used, the equipment can be installed on a solid floor without digging a cable trench. In addition, the rear bottom incoming mode also facilitates the cable from one single to another during side-by-side installation.

Note: When the selected power cable enters the INVinstalled on the solid floor, choose the appropriate cable diameter and reasonable reasonably to ensure that the cable can be smoothly connected to the wiring row of INV.

initial

Before installing the INV:

1. Ensure that the environment of the INVmachine room meets the environmental requirements stipulated in the product technical indicators, especially the environmental temperature, its ventilation conditions and dust conditions.
2. Unpack INVand battery packaging, and visually check whether INVand battery. Please notify the carrier immediately of any damage.

installat

The installation diagram in this section describes the key mechanical characteristics of the INVcabinet.

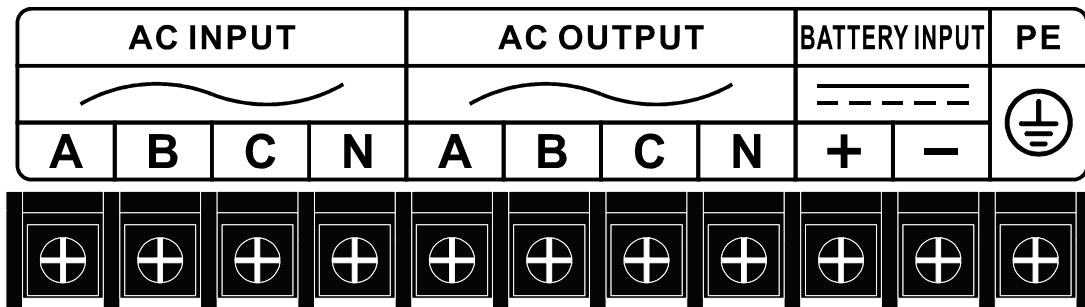
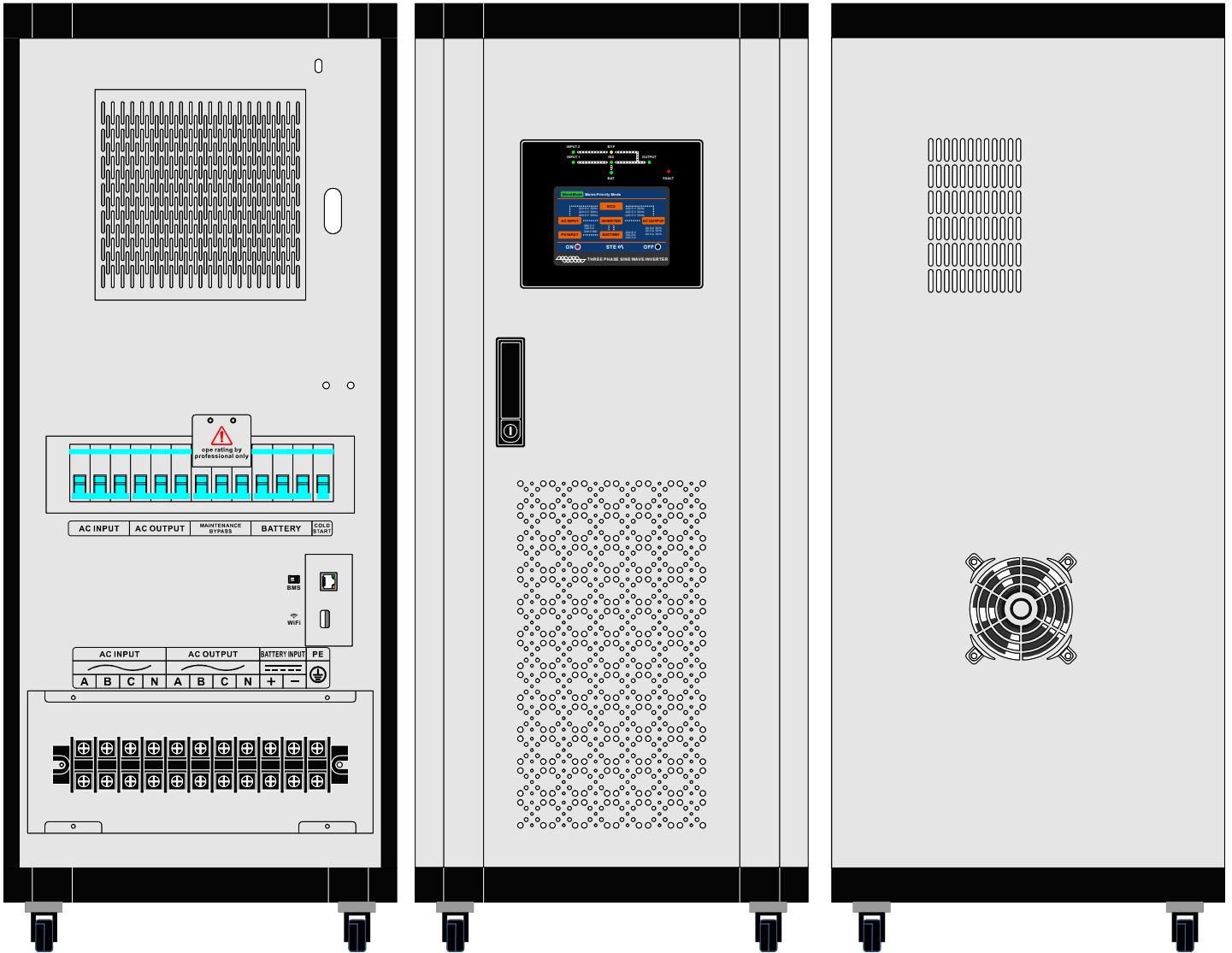

Note: The machine leaves the factory mains input and the bypass input share the zero line, and the three-phase A, B and C input power has been short-connected together.
 If separation bypass is used, remove the connection between bypass and rectifier input

Electrical install

This chapter briefly describes the electrical installation of the power frequency three in three out series INV, including the connection steps or methods of power cables and control cables, as well as the distance of the equipment connection point from the floor.

After the mechanical installation of the INV, the INVis required to connect power and control cables to the I N V . All control cables, whether shielded or not, shall be wired separately from the power cables in the metal pipes, which fastened to the metal parts of the cabinets connected to these power cables.

Power cable wiring



warning

Before wiring the INV, please further confirm the position and status of connecting the INV main circuit input power supply / bypass power supply and the mains power switchboard switch.
Make sure the switches are off and warning marked to avoid operation.

Refer to the incoming mode for the cable.

System configuration

The line diameter of the system power cable shall meet the following requirements:

The ◆ INVinput cable

The line diameter of the INVinput cable varies with the power and input AC voltage of each INV, and should meet the requirements of the maximum input current, including the maximum battery charging current.

◆ INVbypass and output cable

The line diameter of the INVbypass and output cable varies with the power and output AC voltage of each INV, and shall meet the requirements of the nominal output current.

◆ battery cable

Each INV is connected to its battery through two cables of the positive and negative electrodes. The line diameter of the battery cable varies with the power of each INV, and should meet the battery discharge current requirements when the battery approaches the discharge termination voltage.

Cable specification

Different power of the INV, its power cable specifications. **Detailed selection of wire specifications, specific please contact the installation engineer.**

General considerations

The following points provide only general guidance, and if relevant local regulations, local regulations shall prevail.

1. The midline line diameter is selected as 1.5 times of the output / bypass phase current.
2. The line diameter of the protective ground wire shall be selected as twice as the output / bypass wire (depending on the fault level, cable length, protection type, etc.).
3. For cables flowing through large current, thinner cables can be considered in parallel, which can be installed in a large place.
4. When selecting the battery cable diameter, make reference to the current value for the maximum allowable pressure drop of 3Vdc.
5. In most installations, especially the installation of multiple single-machine parallel systems, the load equipment is connected to a separately protected bus distribution network powered by the INVoutput, rather than directly connected to the INV. In this case, the selection of the INVoutput cable diameter should meet the requirements of the output distribution network, but not according to the full load situation of the single machine

Cable connection terminal

Rectifier input, bypass, output and battery power cables (all ends should be pressed with copper nose) are connected to the busbar under the power switch.

Protected

There are grounding rows near the copper row of input and output lines. The protective ground wire shall be connected to the ground row and connected with each cabinet of the system. All cabinets and cable trays shall be grounded in accordance with local regulations. The ground wire should be the wire firmly tied on the turn wire metal beam to prevent the ground wire fastening screws from pulling loose when pulling the ground wire

	<p>warning</p>	<p>Failure to ground as required can cause electric shock and fire hazards.</p>
---	----------------	---

Rectifier and bypass input power

1. Input overcurrent and short-circuit protection

Install appropriate protection device on the main input distribution line and consider the overload capacity of the system.

2. Separate the bypass

If the system adopts separate bypass, separate protection devices shall be installed on the input main and bypass main distribution lines. Depending on the different INV capacity and AC input voltage, the protection device shall be selected by the rated input current.

3. Ground protection, fault protection

If the front-stage input power supply is equipped with a leakage detection instrument (RCD), the transient and steady-state ground leakage current generated by INV startup must be considered.

The internal INV is equipped with an RFI filter inside, so there is a leakage current on the protection ground line, between 3.5 mA and 1000 mA.

The leakage current circuit breaker (RCCB) is sensitive to DC unidirectional pulses (Class A) of the entire distribution network, and is not sensitive to transient current pulses. Their symbols are shown, respectively.

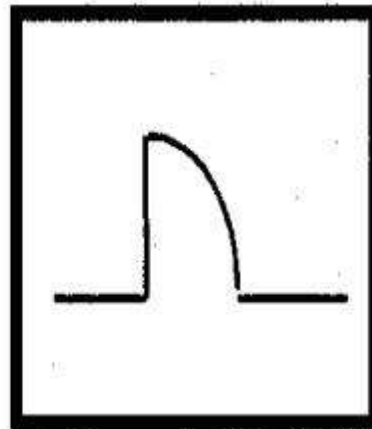
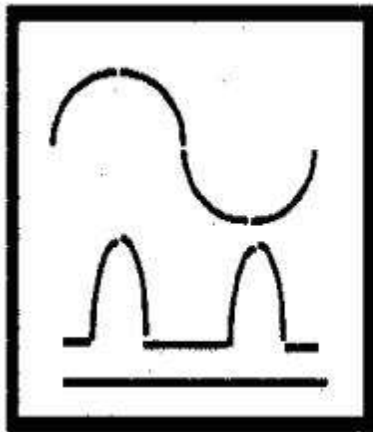

● leakage current Breaker (RCCB) symbol

These switches must have an average sensitivity that can be adjusted between 0.3 A and 1 A.

It is recommended to confirm the sensitivity of each RCD for superior input and subordinate distribution (to load).

Operation control display panel

This chapter details the functions and methods of the power frequency three-in and three-out INVoperation control display panel, and provides LCD display information, including LCD display type, detailed menu information, prompt window information and INValarm information list.

introduce

The operation control display panel of the INV is located on the front door. Through the operation control display panel, the INV operation control, and query for all of the INV parameters, INV and battery status, and event and alarm information. See Figure 4-1.

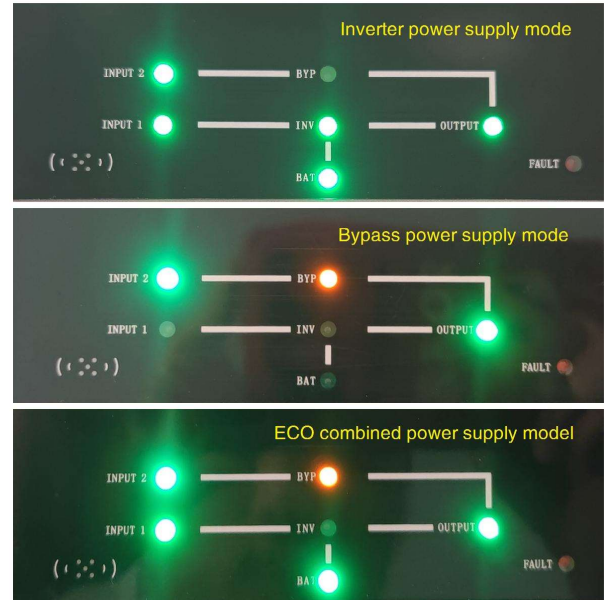
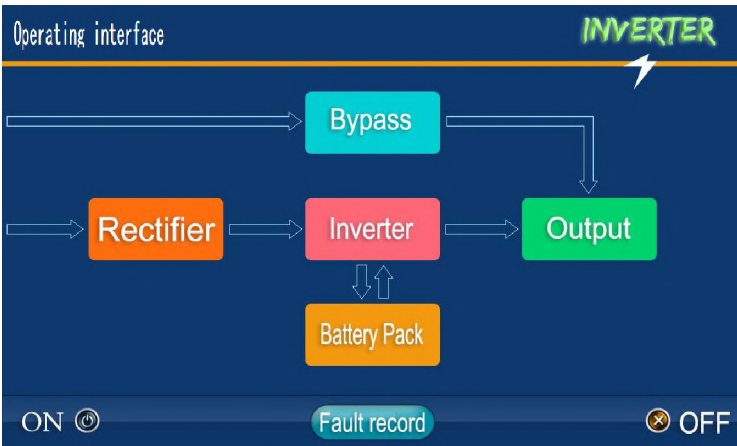

4-1 •INVoperation control display panel

Surface 4-1 Description of LED indicator status

name	state	significance
Rectifier indicator	Green is always on	Rectifier works normally
	Blinking green	The mains supply is normal, but the rectifier does not work
	Extinguish	Rectifier fault, mains supply abnormality
Bypass indicator	Green is always on	Load power supply is provided by bypass
	Yellow flashing	The bypass power supply is abnormal or beyond the normal range, or the bypass switch is faulty
	Extinguish	The bypass is normal, and the load power supply is not provided by the bypass
Battery indicator	Green is always on	During battery charging, when the mains power is interrupted, the load power is supplied by the battery
	Blinking green	Warning of battery discharge termination
	Extinguish	Abnormal battery (battery failure, no battery or battery reverse connection)
Inverter indicator	Green is always on	The load power supply is provided by the inverter
	Blinking green	The inverter is started, started, synchronized or in standby state (ECO mode)
	Extinguish	Inverter does not work Inverter fault
Load indicator	Green is always on	UPS has output and is normal
	Blinking green	UPS has output but overload
	Extinguish	UPS has no output
Warning indicator	Extinguish	Normal operation
	Red flashing	Alarm (e.g. abnormal voltage of main circuit)
	Red is always on	UPS failure (such as main circuit fuse failure or other hardware failure)

Alarm buzzer

Provide an alarm buzzer in the simulated current map area. The INV can be accompanied by three different sound alarms during operation, as shown in Table 4-2

◆ buzzer sound alarm description

Urgent call alarm	Output overload, emit this alarm sound, or battery discharge to terminate the advance alarm
Calling 1 time every 1 second	Sound this alarm during the INV alarm (for example, abnormal main circuit voltage, abnormal bypass power supply,)
Continue to call	This alarm sounds during a INV failure (e. g. main circuit fuse break or other hardware failure)

LCD display type

◆ start INV screen

When the INV starts, the INV starts to perform the self-test, and the start screen appears for about 8 seconds, as shown in Figure 4-3.



● Start the screen

The ◆ main display screen

After the INV starts in and completes the self-detection, the main display screen shown in Figure 4-4 appears. See the 4. 1.5 detailed menu for the main display screen.

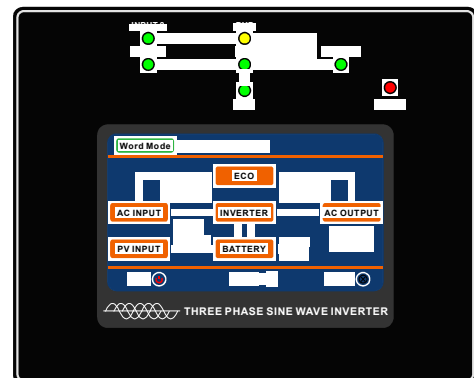
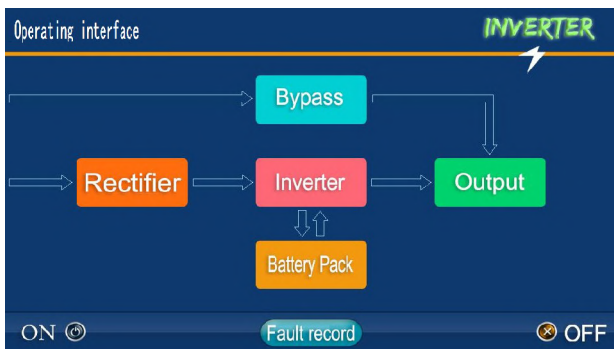

● Start the screen

Through the LCD display interface and the menu-driven operating system for the user, the user can easily browse the input, output, load and battery parameters of the INV, and obtain the current status and alarm information of the INV in time.

The main LCD display screen is divided into the following 6 display Windows: rectification, inverter, bypass, output, battery pack, and fault information.

As shown in Figure 4-3, the emergency Stop (EPO) button is provided on the operation control display panel of the INV. To prevent accidental operation, the outside of the EPO button is covered by a safety cover. When the self-lock EPO button is pressed, all the static switches are blocked (cut off the load power supply), and the rectifier and inverter are turned off. Under normal circumstances, the EPO cannot disconnect the input power supply of the INV because the INV uses the manual closed input circuit breaker. If the INV front-end input adopts an optional switch with the electronic control trip function, the EPO switch drive can trip the external circuit breaker to disconnect the input power supply of the INV.

Set the function

Note: some functions of the custom machine can not be set!

When the INV is finished, click the settings button in the upper right corner of the main screen. The content of the display can be found in the detailed menu below. See table 4-5

- ◆ Set up the main page

Enter the settings pass word click OK, go to the settings page. The content of the display can be found in the detailed menu below. See table 4-5. The initial default password setting is 123456

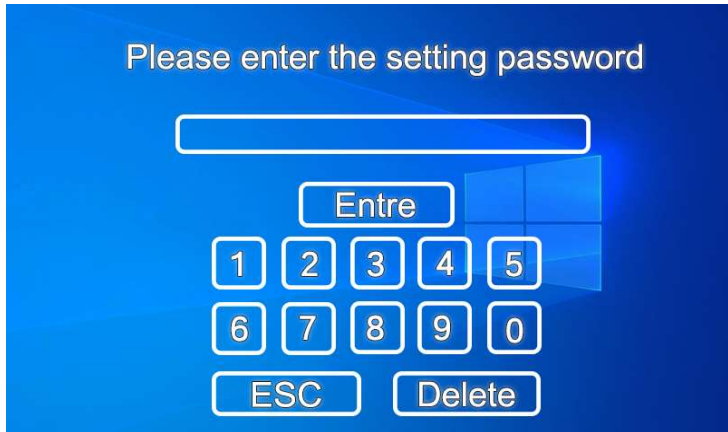

• 4-5

- ◆ Language selection

Click the set page language selection button. The content of the display can be found in the detailed menu below. See table 4-7.



• 4-7

Select the desired Chinese or English button and then click on the confirmation key to quickly switch languages, and return to the main page.

- ◆ Set up the main page

The LCD setup main display is divided into the following 7 windows: Language Selection, ECO mode, battery voltage, battery current, output voltage, warning silencing, back to home page.



• 4-6

- ◆ ECO mode

Click the ECO mode button on the settings page. The content of the display can be found in the detailed menu below. See table 4-8. (the initial default is off)



• 4-8

Select the on or off button for the desired ECO energy saving mode and then click OK to enter the settings page. Click the back button to return to the home page without saving the settings data. Set up to complete the need to completely shut down after power-down from the power is effective.

◆ Battery voltage

Click the battery voltage button on the settings page. The content of the display can be found in the detailed menu below. See table 4-9. (the initial default is 32 sections)



• 4-9

Click the +/- button to select the corresponding number of batteries (the minimum number ranges from 27 to 34), then click the "Confirm" button to save the data and return to the setting page. Point return does not save the Settings data. After the setting is complete, power off the device completely and power it on again. (The number of 12V batteries is one battery)

◆ Battery current

Click the battery current button on the settings page. The content of the display can be found in the detailed menu below. See table 4-10. (the initial default is 10A)



• 4-10

Click the +/- button to select the corresponding battery charging current (the minimum can be set from 5A to 30A), then click the "Confirm" button to save the data and return to the setting page. Point return does not save the Settings data. After the setting is complete, power off the device completely and power it on again

◆ Output voltage

Click the output voltage button on the settings page. The content of the display can be found in the detailed menu below. See table 4-11. (the initial default value is 220V)



• 4-11

Click the +/- button to select the corresponding output voltage (the minimum is from 220Vac to 240Vac) and then click the "Confirm" button to save the data and return to the setting page. Point return does not save the Settings data. After the setting is complete, power off the device completely and power it on again.

◆ Warning silenced

Click on the settings page warning mute button. The content of the display can be found in the detailed menu below. See table 4-12. (the initial default is off)



• 4-12

When there is a warning sound, you can click on or off the button to achieve the warning noise on or off, and then click the confirm key to enter the settings page, and click the back button to return to the home page without saving the settings data. Set up to complete the need to completely shut down after power-down from the power is effective.

◆ Failure record

Click on the fault record button on the main page. The content of the display can be found in the detailed menu below. See table 4-13.



• 4-7

Click on the clear fault button to clear the current fault information in addition to hardware failure can not be cleared, click to return to the home page can be returned to the home page.

◆ History

Click the history button on the fault information page. The content of the display can be found in the detailed menu below. See table 4-14.



• 4-7

Click up or down to view the latest 30 history, click back home page to return to the home page.

Three-phase power frequency machine code table

Fault code definitions	
code	interpretation
1	cBusSoftTimeOut
2	cInvSoftTimeOut
3	cFCUInvVoltShort
10	cFCWInvVoltLow
11	cFCWInvVoltHigh
12	cFCUInvVoltShort
13	cFCVWInvVoltShort
14	cFCWUInvVoltShort
15	cFCOverLoad
16	cFCBusOver
17	cFCBusUnder
18	cFCOverTemp
22	cFCDisOrder
23	cFCLineSCRFault
24	cFCRectifierFault
25	cFCBypSCRFault
26	cFCChargFault
27	cFCInvSCRFault

Fault code definitions	
code	interpretation
28	cFCBusUnbalanceFault
29	cFCBusShortFault
30	cFCFuseOpenFault
31	cFCInvterOverTempFault
32	cFCInvOverCurrentFault
33	cFCRecOverCurrentFault
34	cFCInvIGBTSoftFault
35	cFCOutputShortFault
36	cFCReadEEPromFault
37	cFCBypassOverLoadFault
38	cFCInvFault
39	cFCECOToInvFail
40	cFECOInvOverLoad

Alarm code	
code	interpretation
1	Overload alarm
8	EPO start alarm

INV alarm information list

Table 4-8 is a complete list of all INValarm information that can be displayed under the History menu and in the current record window, as described in the 4. 1.5 detail menu.

INValarm information list

Warning information	Explain
fault clearing	Press Operation Control, the (troubleshooting) key on the display
Manual boot-up failed	Manual failed to boot the inverter. The reason may be invalid operation (phase sequence reverse), phase sequence detection should be detectable when only bypass input
Interrupt switch confirmation	The user switches the load power supply to the bypass based on the disconnected input rectifier and battery blank
Manual boot	Check the boot on the operation control screen, and manually open the inverter and bypass output components
Manual shutdown	Verify the shutdown on the operation control screen, and manually close the inverter and bypass output components
Ambient temperature overwarm	The ambient temperature is too high. Check the ventilation in the INVroom
The battery requires maintenance	The battery test fails, and the battery needs to be replaced
Battery voltage is low for pre-alarm	The battery voltage low pre-alarm appears before the battery reaches the discharge and the final voltage. After then re-warning, the battery capacity is allowed for 3 minutes of full load discharge. At This time, the user can range: with p3 to 60 minutes, please close the load in time
Battery discharge termination	The battery discharge reaches the termination voltage, and the inverter is turned off. Check the state of mains power blackout and restore mains power as soon as possible
Inverter communication failure	Communication between the internal monitoring board and the inverter has failed
The inverter is too warm	Inverter radiator temperature is too high, the inverter stops running. This alarm is triggered by a signal from the temperature monitoring thermostat at the inverter bridge radiator or on the output transformer. After an overtemperature signal and a 5-min delay, INVautomatically recovered. If there is indeed an over-temperature condition, check: 1. Whether the ambient temperature is too high; 2. Whether the air duct is blocked; 3. Whether the fan fault occurs; 4. Whether the inverter overtime overload occurs
The main road voltage is abnormal	The mainvoltage is beyond the normal range, causing the rectifier to turn off. Check the input phase voltage
The main road is under pressure	Municipal power undervoltage. Check the input line voltage
The rectifier is too warm	The high radiator temperature causes the rectifier to stop operation. The INVcan recover by itself. Check the environment and ventilation
The main road phase is reversed	The main circuit input phase order is reverse
Soft start failed	The rectifier cannot start due to the low DC bus voltage
The main road is short of phase failure	Main road input phase deficiency, check the input power wiring or abnormal mainflash
DC bus overpressure	High DC bus voltage closes the rectifier and inverter. Check the rectifier side for faults
emergency cutoff	Emergency stop: directly press the EPO button on the operation control panel or receive an external emergency stop command (the EPO button light is not started, out is started)
Battery inverter power supply	The INVsupplies power to the load through the battery
Automatic boot	The battery discharge termination causes the INVto close, and the inverter automatically starts when the mains recovers
Fan fault	At least one of the cooling fan has failed
Inverter crystal thyristor failure	At least one static switch on the inverter side is disconnected or short-circuit. This fault locks until down
Bypass thyristor fault	At least one static switch on the bypass side is disconnected or short-circuit. This fault locks until down
User operation error	This event is triggered when an error operation occurs
Bypass is abnormal shutdown	Both the bypass voltage and the inverter voltage are abnormal. The load power supply is interrupted
Inverter overflow	Inverter pulse width modulation module is overcurrent
Bypass phase inverse	The bypass voltage phase sequence is reversed. Normally, B lags 120 degrees compared to phase A, and C lags 120 degrees compared to phase B. Check and verify that the INVbypass power supply phase sequence is correct. If there is an error, correct it
Load impact turns to the bypass	Load impact causes the system to switch to a bypass, and the INVrecovers automatically. Open the load in sequence to reduce the inverter load impact

INVoperation introduction

This chapter introduces in detail the operation precautions and daily operation methods of three in and three out INV.

◆ matters need attention



Must be performed by an authorized engineer

Installation and commissioning:

1. After closing the bypass switch, check whether the LCD screen of the device displays normally, and then click the "boot" option on the screen to select the boot, and the device starts to be supplied and output by the bypass. 2. Because the device has an input phase order detection mechanism, if the red light lights on the LCD screen after the bypass switch closes (fault code 22) is the ABC three-phase line order. If caused by the error, please change the correct phase order again. 3. After confirming that the equipment bypass power supply is correct, click the "Shutdown" option on the screen to select the shutdown. After the equipment shutdown is completed, operate as follow.

StartINVstepsBoot step:

1. After closing the bypass switch, check whether the equipment LCD screen is displayed normally, and then click the "bypass" option on the screen to check whether the bypass voltage parameter appears normally. 2. After closing the rectifier switch, click the "rectifier" option on the screen to see whether the rectifier input voltage parameters are normally displayed, then click the "Return to the homepage" option in the lower right corner, click the "boot" boot option on the main page on the screen to confirm the boot, and the device starts rectifying the inverter output. 3. Close the battery switch and the output switch in turn after the normal inverter output, and then disconnect the rectification and bypass switch to power off and simulate the power supply by the battery inverter power supply. After a moment to confirm that there is no abnormal operation, close the rectification and bypass switch equipment to turn the rectification inverter and charge the battery. 4. The equipment supports the cold start of the battery without mains input. The operation steps are as follows: close the right 1P switch for 10 seconds, close the battery switch in turn, select the option of "start" on the screen, close the start switch and close the output switch after the normal inverter power supply operation.

Shutdown procedure:

1. If you need to shutdown, please click the "Shutdown" option on the screen to confirm the shutdown.
2. Disconnect the rectifier switch, bypass switch, output switch and battery switch in turn to complete the shutdown



The authorized engineer must start up and debug it for the first time before the user can perform the relevant operation. The parts behind the protective cover that require tools to open are unoperable. Only qualified maintenance personnel are allowed to open such protective covers.

The AC input and output terminals of the INV have a hazardous voltage at any time. If a CLASS A filter is installed in the machine, it will also have a dangerous voltage.

1. Operation control display panel display and button and power switch involved in all operation steps, refer to Chapter 4 Operation Control display panel. 2. During the operation of operation mode switching, a buzzer alarm will occur. 3. When the INV uses the traditional water-injection lead-acid battery, the INV system provides the optional function of automatic equal charging. When the water injection lead-acid battery is selected, the battery charging voltage is higher than the normal power charging voltage (for 380V AC system, 432Vdc; 400V AC system, 446Vdc; 415V AC system, 459Vdc). This is normal, and after a few hours of charging, the battery charging voltage will return to normal.

◆ mains switch

The power switch installed in the INV cabinet can be seen with the front door. The position of each power switch is subject to the physical type, and they include: rectified input: connect the INV to the input mains.

Bypass input: Connect the INV to the bypass power supply.

Output switch: Connect the INV output to the load.

Maintenance bypass switch (with lock): the bypass can supplies the INV.

If the INV system consists of more than two single INV units in parallel, please do not use the internal maintenance bypass switch.

Battery switch: Connect the INV to the battery pack. (Standard for 10-80kVA machines, optional for other models)

Battery soft start: Connect the INV to the battery pack. (Standard for 10-80kVA machines, optional for other models)

INV start INV tep (enter the inverter power supply mode)

This step is used to power on when the INV is fully powered, where the INV does not power the load or power the load through the service bypass switch. It is assumed that the INV has been installed and commissioned by the Engineer and the external power switch is closed.



Warning that the INV output terminal will have a mains voltage

This procedure brings the INV output terminal with a mains voltage.

If necessary, disconnect the lower load connection switch and place a warning label at the load connection.

1. Open the front door of the INV for a visible power switch (applicable to 100-400K).
2. Close the bypass switch and the INV output switch, and close all external output disconnecting switches (if any).
3. Now, the LCD display is started running. After the system is started, click the boot button on the touch screen to confirm the boot. INV starts automatically and INV works in the bypass power supply state. At this time, the LED, the indicator light status is shown in Table 5.1.

Table 5-1 LED indicator status

Led Name	Status
Bypass input indicator	Green is always bright
Bypass output indicator	Yellow is always bright
Load output indicator	Green is always bright

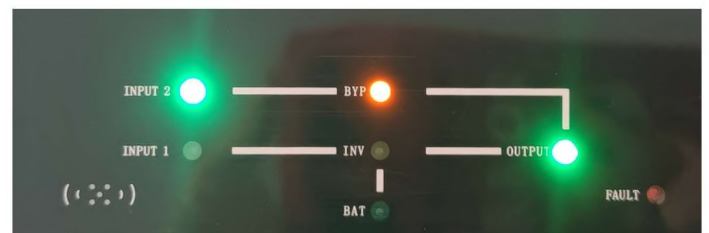

4. Disconnect (or confirm the disconnection) of the internal service bypass switch.
 5. Close the rectifying input switch. The rectifier starts and the rectifier indicator is green. After about 15 seconds, the rectifier begins to operate normally, and the battery pack indicator turns green and bright. The inverter starts automatically, and when the inverter is synchronized with the bypass voltage frequency, the INV switches from the bypass power supply to the inverter power supply. At this point, the bypass indicator is off, and the inverter indicator is green.
 6. Ensure that the bus voltage is normal and the green battery indicator is always on.
- Ensure that the positive and negative polarity of the INV battery access terminal is correct, and close the battery switch;
7. Check and confirm that the lower corner function information in the LCD display screen does not have any alarm information, and the LED display status is as shown in Table 5-2.

◆ Table 5-2 LED indicator status

Led Name	Status
Bypass input indicator	Green is always bright
Rectifier input indicator light	Green is always bright
Battery indicator	Green is always bright
Inverter indicator lamp	Green is always bright
Load output indicator	Green is always bright

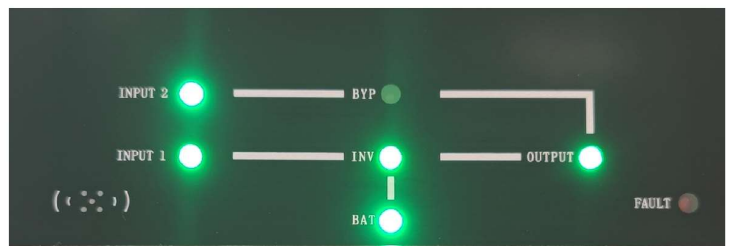

The INV operates in an inverter power supply mode

INV start INV tep (go into economic mode)

When the ECO mode is selected, after completing the operation step described in the 5.7 INV start INV tep (entering the inverter power supply mode), confirm that the operation control display panel bypass indicator is yellow and the inverter light is off (indicating that the load is powered by the ECO economic mode operation).

Note: The ECO economic model should be informed and customized in advance

Battery Test Procedure

Performing the battery test switches the INV to a battery supply mode, which provides 100% of the load supply, supplied by a bypass input when the load supply is insufficient.

Battery test types and prerequisites

1. There are two battery tests available:

- ◆ battery maintenance test: Check the battery status and make the battery perform 20% discharge
- ◆ battery capacity test: accurately detect the battery capacity, fully discharge the battery (until the battery voltage low alarm)

2. The operator can conduct the battery test when the following two conditions are met:

- ◆ load must be within 20% to 80% of the INV rated capacity
- ◆ battery must have just completed more than five hours of floating charging process

Battery test passes mains rectification input operation. In case of battery or inverter failure, the battery test will automatically terminate immediately, and the INV alone will bypass input to the load power supply, and the load power supply will not be interrupted.

Battery Test Procedure

1. Open and close the control rectifier input in the INV operation. The INV automatically turns off the rectifier function and feeds the load. 2. Wait for the battery test to be completed. 2. After the rectification input is closed, the test is completed and the battery test is stopped.

Maintenance bypass operation steps (INV shutdown steps)

The following procedure switch the load from the INV power supply protection state to being directly connected to the AC input bypass power supply via the service bypass switch.



Be careful of load supply interruption

Except for emergencies, to avoid load power supply interruption, please confirm that there is no alarm status warning in the upper right corner of the INV display screen before operation. If the alarm status is prompted, the operator shall cancel the operation.

1. Disconnect the rectifier input and battery input open (models above 100K model, disconnect the external battery switch. The switch is located in the battery switch box). The INV inverter is closed, and the INV supplies the load through a static bypass. At this point, the inverter indicator is off and the buzzer is ts intervals.
2. Close the internal service bypass switch. At this point, the maintenance bypass power supply is connected in parallel with the INV static bypass power supply. That is, maintenance bypass closure, etc.
3. Disconnect the output switch and the bypass input to open it empty. At this time, the INV to the maintenance bypass switch operation has been completed, and the load is directly powered by the maintenance bypass. 4. With all internal power supplies dependent on the mains power supply switched off, all LED indicators on the operation control display panel are switched off and the LCD display is switched off.



pay attention to

At this time, the load equipment has no abnormal protection by the AC power supply.



At this point, the load is powered by the maintenance bypass and the INV is completely off.

Shutdown procedure (completely shut down INV and load)

This procedure should be followed when the INV shutdown completely and power off the load. All power switches and circuit breakers are disconnected and the INV no longer supplies the load.



1. Click the shutdown button on the touch display screen to confirm the shutdown. This operation will close the rectifier and the inverter, disconnect the static switch and the battery, and power off the load. Note: Do not press the Emergency Switch (EPO) button on the INV front door unless urgent.
2. Open the INV door and see the power switch. (10-80K, model power switch on rear panel of INV)
3. Disconnect the rectifier input switch.
4. Disconnect the bypass input switch.
5. Disconnect the INV output switch.
6. Disconnect the external battery switch, the switch above 100K is located in the battery switch box or on the battery cabinet.
7. Confirm that the service bypass switch is disconnected. (This switch is locked and do not open for personnel) With all internal power driven by main off, all LED indicators on the operation control display panel are off and the LCD display is off.
8. In order to completely power off the INV, the external mains distribution switch must be disconnected (for the rectifier and bypass separate bypass system using independent power input) and the external output switch must be disconnected with a warning sign.

Emergency Stop (EPO)

The INV front door provides an emergency stop (EPO) button to close the INV in an emergency situation (such as fire, flood, etc.). If you need to perform an emergency shutdown, you just press the EPO button, the system will turn off the rectifier, inverter, and quickly cut off the load power supply (including inverter and bypass output), and the battery will stop charging.

If the INV still has a mains input, the INV control circuit is still charged, but the INV output is turned off. For completely switching the mains power supply of the INV, remove the external mains input switch of the INV.

INV reset procedure

When the INV shutdown is caused by emergency shutdown (EPO) or inverter overtemperature, overload shutdown, battery overvoltage, excessive switching times and other reasons, measures are taken to clear the fault according to the alarm information prompted on the display screen, and the following INV reset steps are used to make the INV back to the normal working state.

After the user confirms that the fault is cleared and no remote EPO signal, perform the following steps:

1. Press the EPO button to withdraw the system from emergency shutdown and the EPO button.

(The EPO is reset when the EPO button is lit up)

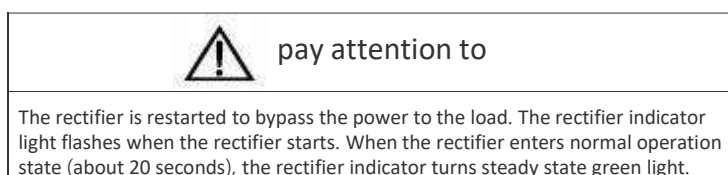

After pressing the EPO button, the INV is completely off the INV. When the mains input is restored, if the bypass input power switch and the INV output power switch are closed, the EPO button has been reset, and the INV will start and enter the bypass mode to restore the output power supply.

Auto start

When the mains is out, INV supplies the load through the battery system until the battery discharges to the battery discharge termination voltage (EOD), and INV stops output. When the following conditions are met, the INV will automatically restart and restore the output power supply.

- ◆ After the recovery of municipal electricity
- ◆ The INV has set up the auto-start function
- ◆ After the automatic start delay (the default is set to 10 kinds).
During the automatic start delay process, the INV charges the battery to
Click the boot button on the touch screen to confirm the boot. Start the INV manually.

Battery

This chapter describes batteries, including battery safety, installation and maintenance information, and battery protection functions, as well as connections between battery switch box options and battery temperature transmitter options.

brief introduction

The battery pack consists of several batteries in series to provide a rated DC input voltage to the INV inverter. The required battery backup time (i. e., when the battery supplies the load when the mains is interrupted) is limited by the safety hours of each battery, so sometimes the array of batteries need to be connected in parallel.

In conjunction with the installation of the power frequency machine, three in and three out of the INV, the battery is usually installed in a specially designed battery cabinet or battery frame.

The battery must be disconnected from the INV during maintenance or repair. This operation can be achieved with a battery switch of a suitable capacity. This switch must be as close as possible to the battery terminal, and the power and INV connection and the control cable wiring distance shall be as short as possible.

security

Special care should be taken when operating the battery of the three-in, three-out INV system. When all the battery cells are connected, the battery pack voltage can reach 460Vdc, which is fatal. Please follow the high-voltage operation safety matters, only qualified personnel can perform the battery installation and maintenance operations. In terms of safety, the first consideration is to install the battery cell in a locked cabinet or in a specially designed special battery room to separate the battery from the personnel (except for qualified maintenance engineers).

INV Battery

INV batteries often use valve-controlled batteries. Currently, "valve control" usually refers to what used to be "sealed" and "maintenance-free".

Valve-controlled batteries are not fully sealed, especially when overcharged, and there is gas discharge. The amount of gas discharged is less than that of the water injection battery, but in the battery installation and design, the battery temperature rise should be considered, leaving enough room to obtain good ventilation.

Similarly, valve-controlled batteries are not maintenance-free. Valve-controlled batteries must be kept clean and regularly checked for reliable connections and corrosion. Refer to battery maintenance for details.

It is recommended that the parallel batteries are not more than four per INV, and different types, names, old and new degrees of batteries are not allowed to be mixed together. Otherwise, due to the inconsistency of the batteries, individual batteries may be overdischarged and undercharged for many times, and finally the single battery fails in advance, causing the insufficient power supply of the whole battery.

The battery must be stored at full charge. Lost some capacity due to self-discharge during transportation or storage period, please supplement the power before use. When storage, the surrounding temperature should not exceed $-15^{\circ}\text{C} \sim +45^{\circ}\text{C}$, the most suitable temperature is $20^{\circ}\text{C} \sim 25^{\circ}\text{C}$. In order to make up for the self-discharge during the battery storage period, it is generally believed that the battery needs to be replenished for three months. Different batteries may be slightly different, so please proceed according to the requirements of the battery manufacturer.

It is critical to fully charge the battery before performing field testing of the battery backup time. The test may take several days to complete, so the battery should be recharged continuously for at least one week.

The battery usually improves after weeks or two or three charge-discharge cycles.

To avoid overcharging or undercharging of the battery, please set the battery management parameters according to the average floating charge voltage and temperature compensation coefficient required in the information provided by the battery manufacturer. Please charge it quickly after the discharge.

Precautions for installation design



take care

Installation precautions for battery use and maintenance are described in the relevant battery manual provided by the battery manufacturer. The battery safety precautions described in this section mainly include important matters that must be considered in the installation design process, and may affect some design results based on local conditions.

Battery mounting environment and battery quantity

Installation environment

◆ Volume of fresh air ventilation (EN50272-2001)

The environment in which the battery is used must be ventilated. When the battery is running, its fresh air ventilation requirements are as follows:

$$Q = 0.05 \times n \times I_{gas} \times C_{rt} \times 10^{-3} \text{ [m}^3/\text{h] of}$$

which: 36/2000

Q-fresh air volume per hour in M3/h

◆ Temperature Operating ambient temperature range

n - Number of cell units

I_{gas} -The gas evolution current density of the battery under the condition of floating charge or even charge, Unit mA/Ah

$I_{gas}=1$ at 2.27V/ monomer floatation

$I_{gas}=8$ at 2.35V/ monomer

C_{rt} -20hr Battery Rating

Category	Temperature value	Notes
The optimum temperature is recommended	20°C-25°C	The ambient temperature of the battery should not be too high or too low. If the average operating temperature of the battery is increased from 25°C to 35°C, the lifetime of the battery will be reduced by 50%; if the operating temperature of the battery is above 40°C, then the life of the battery will be reduced exponentially every day.
Short time available temperature	-15°C ~ 45°C	

The higher the temperature, the shorter the life of the battery. Low temperature, the battery charge and discharge performance will be greatly reduced. Batteries must be installed in a cool and dry environment, to avoid heat and sunlight, environmental humidity less than 90%.

Number of batteries

The nominal DC bus voltage and battery floating charge voltage are set according to the INV rated input/output voltage to ensure the desired floating charge voltage of the cell is 2.25 V, that is, the handling of different cell number is different, see table 6-2.

◆ Number of batteries

Type of aircraft	10/15/20/30/40/60/80	100/120/160/200/250/300/350/400
Quantity of monomer (standard)	192/198/204nly	192/198/204nly
Discharge termination voltage	320/330/340V	320/330/340V
Floating charge voltage	432/446/459V	432/446/459V

Battery protection

The battery is connected to the INV via a battery switch, which is manually closed, and has an electronic trip device controlled by the INV control circuit. If the battery is rack-mounted (or far away from the INV cabinet), the battery switch must be installed as close as possible to the battery, with the power of the INV connection and the control cable lead

Distance should be as short as possible.

The battery switch has the following characteristics:

- ◆ Isolation from the battery, safe and reliable
- ◆ short-circuit protection
- ◆ If the inverter is locked due to the battery undervoltage, the switch breaks automatically to avoid damage to the excessive battery discharge. If the remote emergency stop button is

The battery pack may be connected in parallel to obtain the required backup time. In this case, the battery switch shall be placed in the rear stage position of all parallel battery packs. Note: Only the trainees can perform the maintenance operation of the battery switch.

Battery connection

Battery assembly

1. Before installation, check the appearance of the battery without damage and check the complete accessories completely, and read this manual and the user manual or installation instructions provided by the battery manufacturer in detail.
2. There must be a minimum 10mm interval between the vertical sides of the battery to keep the air around the battery free.
3. There must be some space between the top of the battery and the upper frame for the monitoring and maintenance of the battery.
4. Battery installation always starts from the bottom layer and goes up layer by layer in case the center of gravity is too high. Position the battery to avoid vibration and shock.

Battery wiring

1. All battery cabinets or battery racks must be connected together and well grounded.
2. When using multiple sets of batteries, be in series and then in parallel. Power can be loaded only after measuring the total voltage of the battery pack is correct. Be sure to connect the positive and negative battery terminal of the battery and the positive and negative battery terminal of the INV respectively according to the labels on the battery and the INV. If the polarity of the battery during the connection occurs wrong, it may cause an explosion, a fire, and the damage to the battery, the INV, and possibly cause personal injury.
3. After the battery terminal wiring is completed, the insulation cover shall be installed for each terminal.
4. When connecting the cable between the battery terminal and the battery switch, it should first start from the switch end.
5. The bending radius of the cable should be greater than 10D, where D is the outer diameter of the cable.
6. After the battery cable is connected, do not pull the battery cable or cable terminal again.
7. When connecting, please do not cross the battery cables, let alone tie the battery cables together.

Installation of battery

Regardless of the type of installation system used, the following conditions must be noted (see Figure 61):

◆ **single battery layout**

Regardless of the battery installation system used, the battery placement principle shall ensure that two exposed live parts with a potential difference greater than 150V are not contacted at the same time. If unavoidable, it must be made using insulated terminal covers and insulated cables.

◆ **staging**

The workbench (or pedal) must be non-skid, insulated, and at least one meter wide.

◆ **wiring**

All wiring must be as short as possible.

◆ **battery switch**

Battery switches are generally installed in boxes on a wall close to the battery.

The following section describes the method of connecting

the battery switch box for three in and three out INV of MF power frequency machine.

● **battery room design**

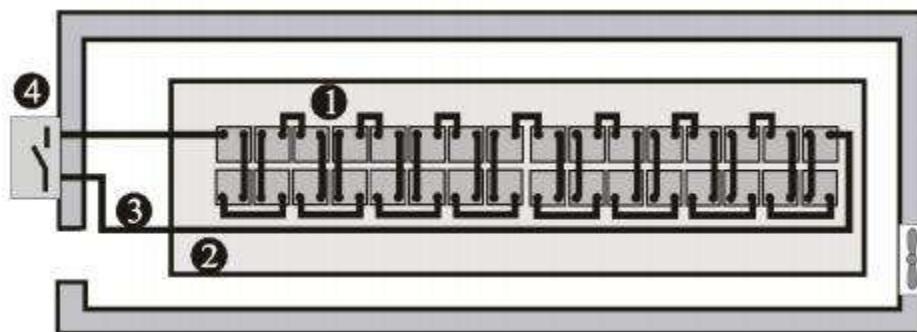

Battery temperature transmitter (option)

A battery temperature transmitter (model: TMP 12Z) is also provided, connected to the INV logic circuit through the battery switch control board. See Figure 6-5 for specific connections. Through this function, the floating charge voltage of the battery can be adjusted to be inversely proportional to the ambient temperature of the battery cabinet / chamber, preventing the battery from overcharging at high ambient temperature.

Battery maintenance

Battery maintenance and maintenance precautions Please follow the IEEE-Std-1188-2005 and the relevant manuals provided by the battery manufacturer.



Regularly check whether the battery connection part screws are not tightened or are loose. For the loose one, it must be tightened immediately. Check to ensure that all applied safety equipment is free and functional, especially whether the battery management parameters are normal. Measure and record the air temperature in the battery room. Check battery terminals for damage or heat, and housing or cover.

Battery recycling

In case of battery leakage or damage, place the battery in an acid-resistant container and scrap it according to local regulations.

Waste lead-acid batteries belong to hazardous waste and are one of the key points of the national pollution control of waste batteries. Their storage, transportation, utilization, disposal and other related activities must abide by the national and local laws, regulations and other standards on the prevention and control of hazardous waste and waste battery pollution.

According to the relevant regulations of the State, waste lead-acid batteries shall be recycled and shall not be disposed of by other means. Random discarding of waste lead-acid batteries or any other improper disposal of the behavior may cause serious environmental pollution and be investigated for the corresponding legal responsibility.

As a supplier of lead-acid batteries, the company has built a perfect service and waste battery recycling system to help customers to properly dispose of waste lead-acid batteries according to law. More information about the company's waste battery recycling system is obtained from the company's location or nearest office. If the customer does not accept this special note or chooses to use the waste battery recycling system provided by the Company, the Company will not bear any environmental responsibility arising from the improper disposal of the waste battery products.

Maintenance

The INVsystem (including the battery) requires regular maintenance and maintenance during the long-term operation. The maintenance of the battery part has been clarified in Chapter VI, which mainly describes the life characteristics of the various INVkey devices and its recommendations for regular inspection and maintenance and replacement. The INVsystem effectively maintained and maintained can provide longer working life and less risk of failure.

security



warn

The Daily inspection of the INVsystem may be conducted by the relevant trained personnel, and the inspection and replacement of its devices shall be operated by the authorized professionals.

INVkey components and their service life

During the use of the INV, some of these devices have a shorter service life than the INVitself due to the presence of wear at work. For the power supply safety of the INVsystem, the devices need to be checked and replaced regularly. This section introduces the key components of three in and three out INVand the reference life of its working life. For systems under different service conditions (environment, load rate, etc.), refer to this section to be evaluated by professionals and advise on whether the devices need to be replaced.

◆ Magnetic element: transformer, inductor

The design service life of the magnetic elements is 20 years. The key factor affecting its service life is the insulation system between the windings and the temperature rise in the operation. The three-in and three-out INVadopts the H-class insulation system, which can withstand the working temperature of up to 220°C, generally working under the forced air cooling conditions of the system.

◆ power semiconductor device

Power semiconductor devices include a silicon-controlled rectifier (SCR) and an insulated gate bipolar transistor (IGBT). In the normal working state of the INV, the power semiconductor devices have no rated working life years. The failure of SCR and IGBT is always caused by other problems, and there is no problem of life expiration. However, during the maintenance and maintenance process of the system, the appearance of power semiconductor devices should be regularly checked for corrosion or shell damage. The devices with a risk of failure should be replaced.

Life parameters and recommended replacement times for ◆ key devices

Key devices are used in INVsystems, and to prevent system failure due to working wear and tear, it is recommended to be checked regularly, and replaced within their expected life span.

Life parameters and recommended replacement times for ◆ key devices

Key devices	Life expectancy	Replacement period is recommended	It is recommended to check the cycle
AC capacitance	7 Years (approximately 62,000 hours)	5~6 Years	Six months
electrolytic capacitor	7 Years (approximately 62,000 hours)	5~6 Years	In 1 year
electric fan	7 Years (approximately 62,000 hours)	5~6 Years	In 1 year
airstrainer	1~3 Years	1~2 Years	A month
Valve-controlled lead-acid battery (5-year life)	Five years	3~4 Years	Six months
Valve-controlled lead-acid battery (10-year life)	In 10 years	6~8 Years	Six months

◆ replacement insurance coverage

When replacing the insurance on the high voltage power board, the same type of insurance should be used to avoid misleading caused by the parameter screen printing on the safety box. The 380V system can have 380V / 4A and 500V / 4A insurance, and the 400V / 415V system can only use 500V / 4A insurance.

Identification table of toxic

Part name	Toxic and harmful substances or elements					
	lead	mercury	cadmium	hexavalent chromium	Polybrominated biphenyl	Polybromine biphenyl ether
	P b	H g	C d	Cr 6+	PBB	PBDE
Chassis / enclosure / copper row	×	○	○	○	○	○
Hardware / fasteners	×	○	○	○	○	○
plastic parts	×	○	○	○	○	○
radiator	×	○	○	○	○	○
manufactured board	×	○	○	○	○	○
AC capacitance	×	○	○	○	○	○
DC capacitor	×	○	○	○	○	○
electric fan	×	○	○	○	○	○
cable	×	○	○	○	○	○
display screen	×	×	○	○	○	○
detecting element	×	○	○	○	○	○
Medium-and high-power magnetic components	×	○	○	○	○	○
Distribution switch (open / contactor)	×	○	○	○	○	○
fuse	×	○	○	○	○	○
Contactor (when applicable)	×	○	○	○	○	○
semiconductor device	×	○	○	○	○	○
<p>○: Indicates that the content of the toxic or harmful substance in all homogeneous materials of the component is below the limit requirements specified in SJ / T-11363-2006 ×: Indicates that the content of the toxic or harmful substance in at least one homogeneous material of the component exceeds the limit requirements specified in SJ / T 11363-2006</p> <p>The company has been committed to the design and manufacture of environmentally friendly products, and we will continue the research to reduce and eliminate the toxic and harmful substances in the products. The following components or applications containing toxic and harmful substances are limited to the current technical level to achieve reliable alternatives or no mature solutions:</p> <ol style="list-style-type: none"> 1. Welder contains lead 2. Copper alloys contain lead 3. The backlight tube contains mercury <p>About the service period of environmental protection: the environmental protection service period of the product (identified in the product ontology), refers to the in the normal use conditions and comply with the safety precautions of the product, from the production date the product contains toxic and harmful substances or elements will not cause serious impact on the environment, personal and property period.</p> <p>Application: 120 / S / 6P, 160 / S / 6P, SP200 / S / 6P, 160 / S / 12P, 200 / S / 12P, 300 / S / 6P, 300 / S / 12P, 400 / S / 6P, 400 / S / 12P</p>						

Note: This manual is universal for the three camera series, such as physical appearance and function page upgrade without notice, mainly physical! The company reserves the right of final interpretation and compilation of this specification.

Version 2022-2

MODEL	10KW	15KW	20KW	30KW	40KW	50KW	60KW	80KW	100KW	120KW	150KW	200KW
Rated power	10KW	15KW	20KW	30KW	40KW	50KW	60KW	80KW	100KW	120KW	150KW	200KW
Surge rating (20ms)	30KW	45KW	60KW	90KW	120KW	150KW	180KW	240KW	300KW	360KW	300KW	600KW
OUTPUT												
Wave form	Pure sine wave											
Rated voltage	380,400/415VAC											
Output frequency	50Hz/60z±0.1% in battery mode											
Input wiring	Three-Phase five-wire (3)											
Total harmonic distortion	Linear load < 3%; Non - linear load < 5%											
Crest factor	3:1											
Overload	105%-110% for 60 min,110%-125% for 10min											
INPUT												
Phase	Three Phase + N+G											
Voltage	380,400/415VAC											
Rated frequency	50Hz/60Hz											
Frequency range	50Hz/60Hz±5Hz											
Voltage range	285-475V											
Inverter efficiency(Peak)	>95%											
Delayed stage of rectifier	10s(1-300 settable)											
Bypass voltage range	±20%(settable)											
Battery												
DC voltage	96VDC	√	√	/	/	/	/	/	/	/	/	/
	192VDC	√	√	√	√	/	/	/	/	/	/	/
	384VDC	√	√	√	√	√	√	√	√	√	√	√
Battery type	Lead Acid or Lithium											
Charging current	20A					40A						
Other												
Protection	Short circuit, overload, overvoltage, undervoltage, low battery, overtemperature, fan fail											
Mounting	Vertical mount											
Display	LCD+LED											
Cooling fan	Forced ventilation											
Audible noise	<60dB											
Communications	RS-232, RS485, WI-FI(Optional)											
Communication with BMS	CAN											
Operation temperature range	-10°C~50°C											
Storage temperature	-10° C ~ 60° C											

*All specifications are subject to change without notice